



PYLONTECH



Rechargeable Li-ion Battery US2000C Operation Manual

Information Version: 1.0
20CPSV0901

This manual introduces US2000C from Pylontech. Please read this manual before you to install the battery and follow the instruction carefully during the installation process. Any confusion, please contact Pylontech immediately for advice and clarification.

1. Safety Precautions	1
1.1 Before Connecting	2
1.2 In Using	2
2. Introduction	3
2.1 Features	3
2.2 Specification	4
2.3 Equipment interface instruction	6
Definition of RJ45 Port Pin	8
3. Safe handling of lithium batteries guide	10
3.1 Schematic diagram of solution	10
3.2 Danger label	10
3.3 Tools	11
3.4 Safety gear	11
4. Installation and operation	12
4.1 Package items	12
4.2 Installation location	13
4.3 Grounding	15
4.4 put into cabinet or racks	16
4.5 Put into bracket	18
4.6 power on	21
4.7 Power off	22
4.8 Multi-group mode	23
5. Trouble shooting.	25
6. Emergency Situations	27
7. Remarks	29

1. Safety Precautions



Reminding

- 1) It is important and necessary to read the user manual carefully (in the accessories) before installing or using battery. Failure to do so or to follow any of the instructions or warnings in this document can result in electrical shock, serious injury, or death, or can damage battery, potentially rendering it inoperable
- 2) If the battery is stored for long time, it is required to charge them every six months, and the SOC should be no less than 90%
- 3) Battery needs to be recharged within 12 hours, after fully discharged
- 4) Do not install the product in outdoor environment, or an environment out of the operation temperature or humidity range listed in manual.
- 5) Do not expose cable outside
- 6) Do not connect power terminal reversely.
- 7) All the battery terminals must be disconnected for maintenance
- 8) Please contact the supplier within 24 hours if there is something abnormal.
- 9) Do not use cleaning solvents to clean battery
- 10) Do not expose battery to flammable or harsh chemicals or vapors
- 11) Do not paint any part of battery, include any internal or external components
- 12) Do not connect battery with PV solar wiring directly
- 13) The warranty claims are excluded for direct or indirect damage due to items above.
- 14) Any foreign object is prohibited to insert into any part of battery

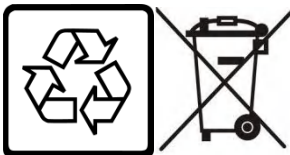

Li-ion ████████



Warning

1.1 Before Connecting

- 1) After unpacking, please check product and packing list first, if product is damaged or lack of parts, please contact with the local retailer
- 2) Before installation, be sure to cut off the grid power and make sure the battery is in the turned-off mode
- 3) Wiring must be correct, do not mistake the positive and negative cables, and ensure no short circuit with the external device
- 4) It is prohibited to connect the battery and AC power directly
- 5) The embedded BMS in the battery is designed for 48VDC, please DO NOT connect battery in series
- 6) Battery must connect to ground and the resistance must be less than 0.1Ω
- 7) Please ensured the electrical parameters of battery system are compatible to related equipment
- 8) Keep the battery away from water and fire.

1.2 In Using

- 1) If the battery system needs to be moved or repaired, the power must be cut off and the battery is completely shutdown
- 2) It is prohibited to connect the battery with different type of battery.
- 3) It is prohibited to connect batteries with faulty or incompatible inverter
- 4) It is prohibited to disassemble the battery (QC tab removed or damaged);
- 5) In case of fire, only dry powder fire extinguisher can be used, liquid fire extinguishers are prohibited
- 6) Please do not open, repair or disassemble the battery except staffs from Pylontech or authorized by Pylontech. We do not undertake any consequences or related responsibility which because of violation of safety operation or violating of design, production and equipment safety standards.

2. Introduction

US2000C lithium iron phosphate battery is the new energy storage products developed and produced by Pylontech, it can be used to support reliable power for various types of equipment and systems.

US2000C has built-in BMS battery management system, which can manage and monitor cells information including voltage, current and temperature.

2.1 Features

- 1) NEW: Build-in soft-start function able to reduce current strike when inverter need to start from battery.
- 2) NEW: Dual active protection on BMS level.
- 3) NEW: Automatic address setting when connect in multi-group.
- 4) NEW: Support wake up by 5~12V signal from RJ45 port.
- 5) NEW: Support upgrade battery module from upper controller via CAN or RS485 communication.
- 6) NEW: Enable 95% depth of discharge, available for the inverter which completely follow Pylontech latest protocol to operate.
- 7) The module is non-toxic, non-polluting and environmentally friendly
- 8) Cathode material is made from LiFePO₄ with safety performance and long cycle life
- 9) Battery management system (BMS)has protection functions including over-discharge, over-charge, over-current and high/low temperature
- 10) The system can automatically manage charge and discharge state and balance voltage of each cell
- 11) Flexible configuration, multiple battery modules can be in parallel for expanding capacity and power
- 12) Adopted self-cooling mode rapidly reduced system entire noise
- 13) The module has less self-discharge, up to 6 months without charging it on shelf, no memory effect, excellent performance of shallow charge and

discharge

- 14) Small size and light weight, standard of 19-inch embedded designed module is comfortable for installation and maintenance
- 15) Compatible with the US2000C, US3000, and US2000.

2.2 Specification

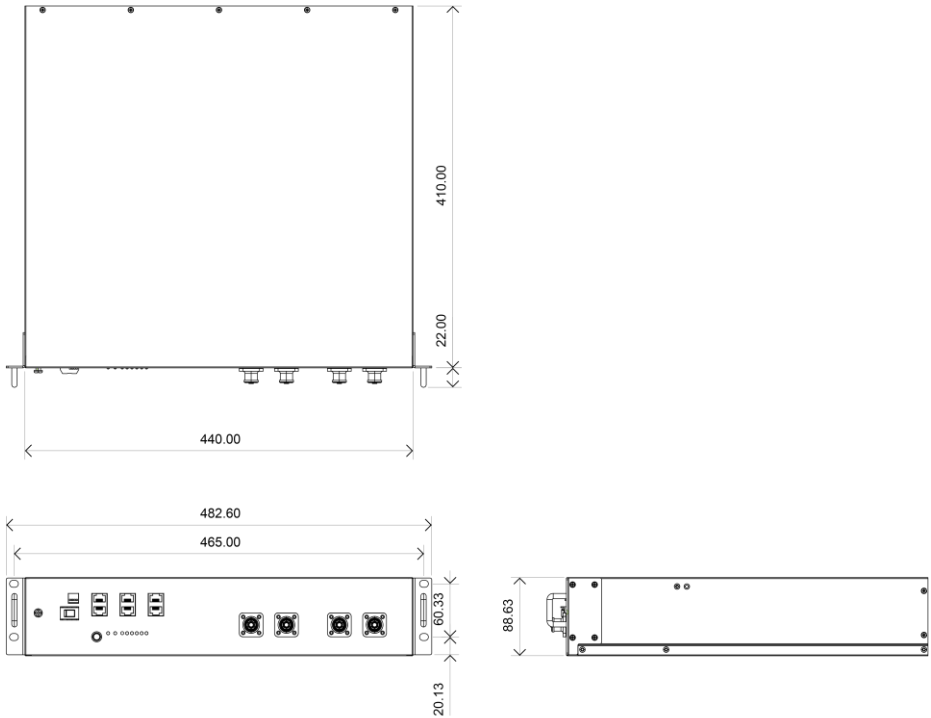

Basic Parameters	US2000C
Nominal Voltage (V)	48
Nominal Capacity (Wh)	2400
Usable Capacity (Wh)	2280
Dimension (mm)	442*420*89
Weight (Kg)	22.5
Discharge Voltage (V)	44.5 ~ 53.5
Charge Voltage (V)	52.5 ~ 53.5
Recommend Charge/Discharge Current (A)	25
Max. Charge/Discharge Current (A)	50
Peak Charge/Discharge Current (A)	90A@15sec
Communication	RS485, CAN
Depth of discharge (%)	95
Configuration (max. in 1 battery group)	16pcs
Working Temperature	0°C~50°C Charge
	-10°C~50°C Discharge
Shelf Temperature	-20°C~60°C
Protective class	I
IP rating of enclosure	IP20
Humidity	5 ~ 95%(RH)
Certification	TÜV / CE / UN38.3
Design life	10+ Years (25°C/77°F)
Cycle Life	>4,500 25°C
Reference to standards	IEC62619, IEC63056 UL1642, IEC61000-6-2, IEC61000-6-3, UN38.3

2.3 Equipment interface instruction

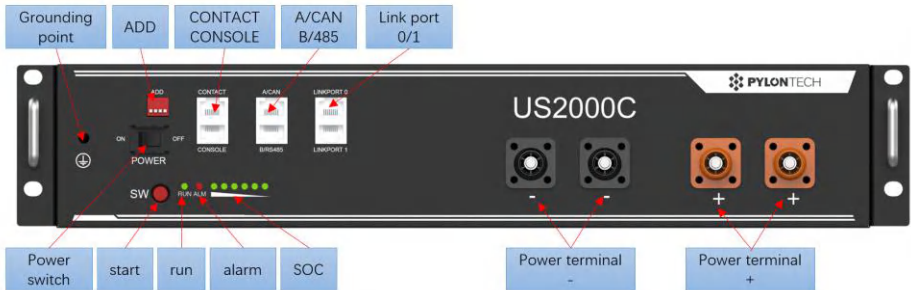

Power Switch

ON: ready to turn on.

OFF: power off. For storage or shipping.

Start

Turn on: press more than 0.5s to start the battery module

Turn off: press more than 0.5s to turn off the battery.

RUN

Green LED lighting to show the battery running status

Alarm

Red LED flashing to show the battery has alarm; lighting to show the battery is under protection.

SOC

6 green LEDs to show the battery's current capacity.

ADD Switch

Dip1: RS485 baud rate 1: 9600; 0: 115200

Dip2~4, reversed.

Console

For manufacturer or professional engineer to debug or service.

Pin3	232-TX
Pin4*	+5~+12V for wake up
Pin5*	GND for wake up
Pin6	232-RX
Pin8	232-GND
*Wake up signal shall ≥ 0.5 Sec, current between 5~15mA. After send wake up signal, the voltage shall disappear for normal operation.	

Contact

Pin1	Input, passive signal. On: turn off battery. Off: normal.	
Pin2		
Pin3	Output1. On: stop charge.	+
Pin4		-
Pin5	Output2. On: stop discharge.	+
Pin6		-
Pin7	Output3. On: BMS error.	+
Pin8		-

Output request signal voltage ≤ 25 V

CAN

500 Kbps. 120 Ω . For connection to LV-HUB, inverter, or upper battery.

RS485

9600 or 115200 bps. 120 Ω . For connection to inverter, or slave battery.

Link Port 0, 1

for communication between multiple parallel batteries.

Definition of RJ45 Port Pin

	A/CAN	B/RS485
Pin1	Shall be NULL.	
Pin2	If not, may influence BMS function.	
Pin3		
Pin4	CAN-H	CAN-H (single group)
Pin5	CAH-L	CAN-L (single group)
Pin6	CAN-GND	CAN-GND (single group)
Pin7	485A	485A
Pin8	485B	485B

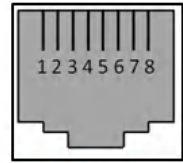

RJ45 Port

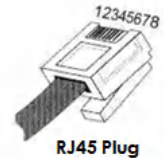

RJ45 Plug

Power Terminals

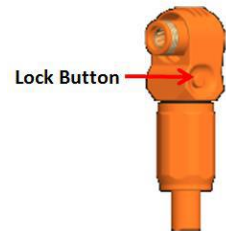

Power cable terminals: there are two pair of terminals with same function, one connects to equipment, the other one paralleling to other battery module for capacity expanding.

For power cables uses water-proofed connectors. must keep pressing this Lock Button while pulling out the power plug.



LED Status Indicators

Condition	RUN	ALR	1	2	3	4	5	6
Power off	-	-	-	-	-	-	-	-
Power on	●	●	●	●	●	●	●	●
Idle/Normal	■	-	-	-	-	-	-	-
Charge	●	-	Show soc; highest LED flash on: 0.5s; off 0.5s					
Discharge	■		Show soc					
Alarm	ALR: ■; Other LEDs are same as above.							
System error/Protect	-	●	-	-	-	-	-	
●/●	ON							

	flash, on: 0.3s; off: 3.7s
	flash, on:0.5s; off: 1.5s

BMS basic function

Protection and alarm	Management and monitor
Charge/Discharge End	Cells Balance
Charge Over Voltage	Intelligent Charge Model
Discharge Under Voltage	Charge/Discharge Current Limit
Charge/Discharge Over Current	Capacity Retention Calculate
High/Low Temperature(cell/BMS)	Administrator Monitor
Short Circuit	Operation Record
	Power Cable Reverse
	Soft start of inverter

3. Safe handling of lithium batteries guide

3.1 Schematic diagram of solution

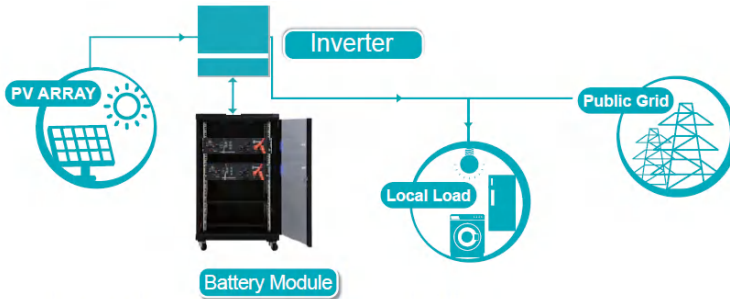

3.2 Danger label

DANGER
DANGER LOW DC VOLTAGE INSIDE
DANGER ARC FLASH & SHOCK HAZARD

A vertical column of eight safety icons: 1. Yellow triangle with exclamation mark. 2. Red circle with slash and flame. 3. Red circle with slash and fire. 4. Red circle with slash and children. 5. Yellow triangle with lightning bolt. 6. Yellow triangle with flame. 7. Yellow circle with person working. 8. Black trash bin with a red 'X' over it.

- * Do not disconnect or disassemble by non-professional personnel.
- * Do not drop, deform, impact, cut or spearing with a sharp object.
- * Do not place at a children or pet touchable area.
- * Do not place near open flame or flammable material.
- * Do not cover or wrap the product case.
- * Do not sit or put heavy things on battery.
- * Do not touch the leaking liquid.
- * Avoid of direct sunlight.
- * Avoid of moisture or liquid.
- * The product Ingress Protection (IP) class is IP20.
- * Make sure the grounding connection set correctly before operation.
- * Follow the product manual to make wiring connection.
- * If leaking, fire, wet or damaged, switch off the breaker on DC side and stay away from battery.
- * Contact your supplier within 24 hours if anything failure happens.

3.3 Tools



Wire cutter



Crimping modular plier



Screwdriver

NOTE

Use properly insulated tools to prevent accidental electric shock or short circuits. If insulated tools are not available, cover the entire exposed metal surfaces of the available tools, except their tips, with electrical tape.

3.4 Safety gear

It is recommended to wear the following safety gear when dealing with the battery pack



Insulated gloves



Safety goggles



Safety shoes

4. Installation and operation

4.1 Package items

Unpacking and check the Packing List

1) For battery module package:

Two power cables and one communication cable for each battery package:

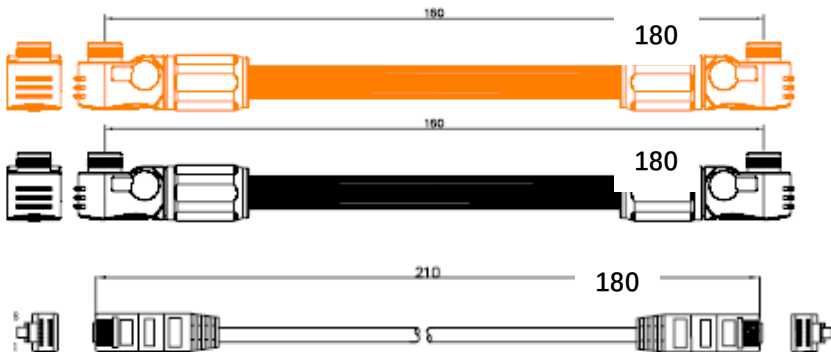

Grounding cable:

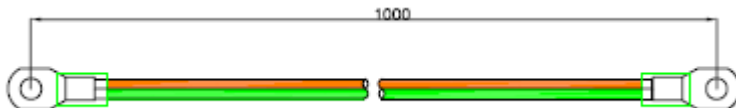

2) For battery system connects to inverters:

Two long power cables (current capacity **120A**, constant 100A) and one communication cable for each energy storage system:

NOTE

These three cables are belonging to External Cable Kit, **NOT in battery package**. They are in another **extra small cable box**. If there is anything missed please contact dealer.

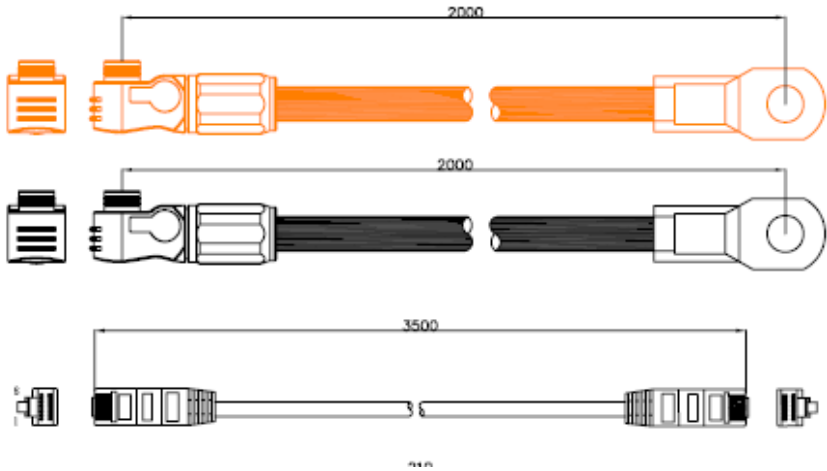

4.2 Installation location

Make sure that the installation location meets the following conditions:

- 1) The area is completely waterproof
- 2) The floor is flat and level.
- 3) There are no flammable or explosive materials.
- 4) The ambient temperature is within the range from 0°C to 50°C.
- 5) The temperature and humidity is maintained at a constant level.
- 6) There is minimal dust and dirt in the area.
- 7) The distance from heat source is more than 2 meters.
- 8) The distance from air outlet of inverter is more than 0.5 meters.
- 9) The installation areas shall avoid of direct sunlight.
- 10) There is no mandatory ventilation requirements for battery module, but please avoid of installation in confined area. The aeration shall avoid of high salinity, humidity or temperature.



Caution

If the ambient temperature is out of the operating range, the battery stops operating to protect itself. The optimal temperature range for the battery pack to operate is 10°C to 40°C. Frequent exposure to harsh temperatures may deteriorate the performance and life of the battery.

4.3 Grounding

Grounding cables shall be 10AWG or higher yellow-green cables. After connection, the resistance from battery grounding point to Ground connection point of room or installed place shall smaller than 0.1Ω.

- 1) based on metal directly touch between the module's surface and rack's surface. If using painted rack the corresponding place shall remove the painting.
- 2) install a grounding cable to the grounding point of the modules.



4.4 put into cabinet or racks

Put battery modules into cabinet and connect the cables:



- 1) Put the battery into the cabinet
- 2) Drive the 4 pcs screws
- 3) Connect the cables between battery modules
- 4) Connect the cables to inverter



4.5 Put into bracket

- 1) Dismantle the 2 holders of battery.



- 2) Put the battery into 2 pcs of bracket.

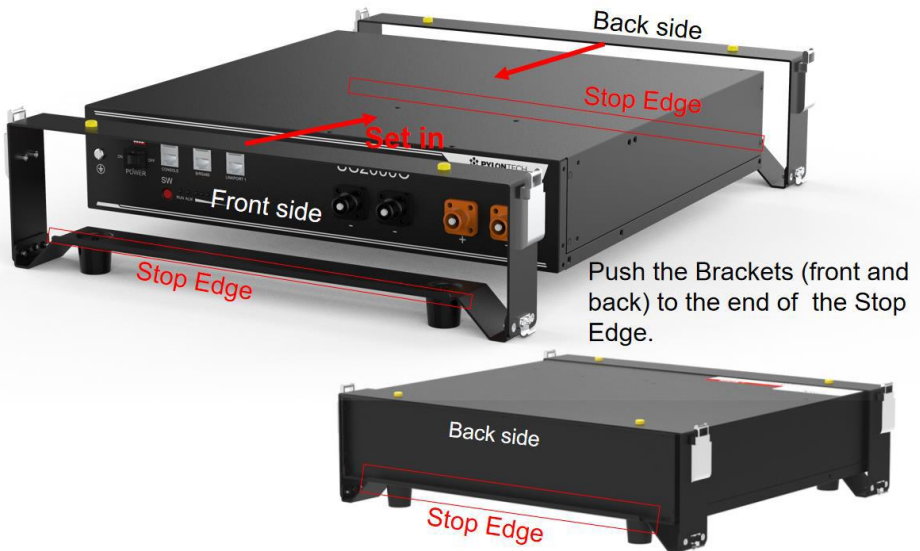



- 3) Use 4 location holes, stack the batteries together. And connect the 4 locker together.

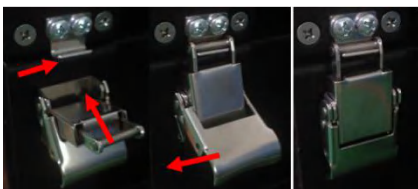

- 4) Maximum 4 in stack.



NOTE

After installation, do not forget to register online for full warranty:
<http://www.pylontech.com.cn/service/support>



Caution

- 1) a suitable breaker between battery system and inverter is required.
- 2) all the installation and operation must follow local electric standard.

4.6 power on

Double check all the power cable and communication cable.

3) Switch on all the battery modules:

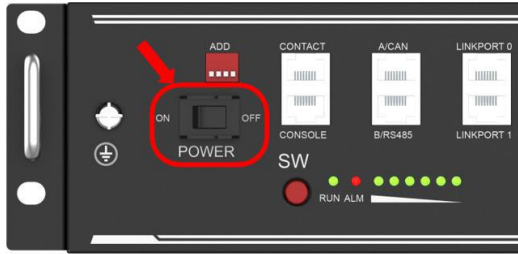

4) The one with **empty Link Port 0** is the **Master Battery** Module, others are slaves (1 master battery configure with maximum 15 slave batteries):

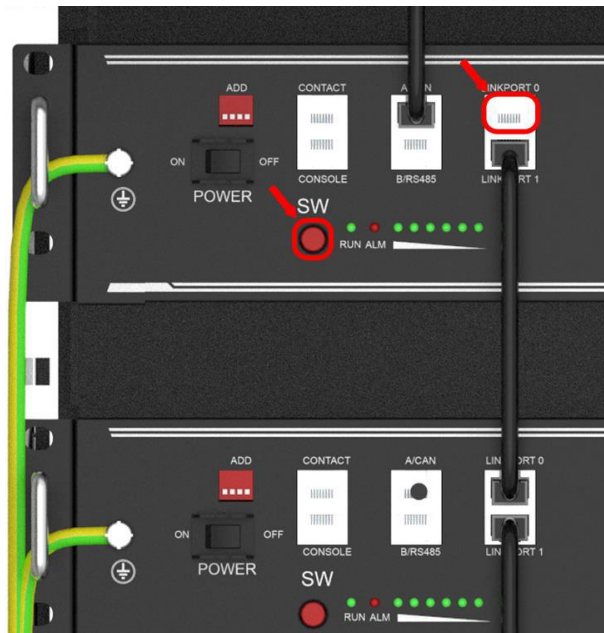

5) Press the **red SW button of master battery** to power on, all the battery LED light will be on one by one from the Master battery:



Note:

- 1) After the battery module powered on, the soft-start function takes **3sec** to active. After soft-starts battery ready to output high power.
- 2) During capacity expansion or replacement, when parallel different SOC/voltage of module together, please maintain the system in idle for ≥ 15 mins or till the SOC LEDs becomes similar (≤ 1 dot difference) before normal operation.

4.7 Power off

- 1) Turn external power source off.
- 2) Press red SW switch of master battery. Then all batteries will off.
- 3) Switch Power switch OFF.

4.8 Multi-group mode

By RS485: DO NOT need LV-HUB.

Connect power cable first:

- 1) each pair of cable hold max 120A constant current. Connect enough pairs of cable based on calculation of system current.
- 2) Suitable protection breaker between battery system and inverter is required.



- 3) Make sure all dip switch of master batteries are R0XX, then turn ON batteries.

R: is the baud rate of RS485 needed, all master batteries shall be the same.

- 4) After all batteries running and buzzer of master battery in group1 rings 3 times. Means all groups are online.

The interruption of each RS485 command shall at least ≥ 1 s.

Multiple Battery Groups RS485 Communication Cable Connection

Max 6 groups

- 1) The A/CAN of 1st group/master battery connects to inverter or EMS(pin: 7A, 8B, **DO NOT connect other pins**)
- 2) The B connect to A of next group; the B/RS485 of last group master battery is empty.

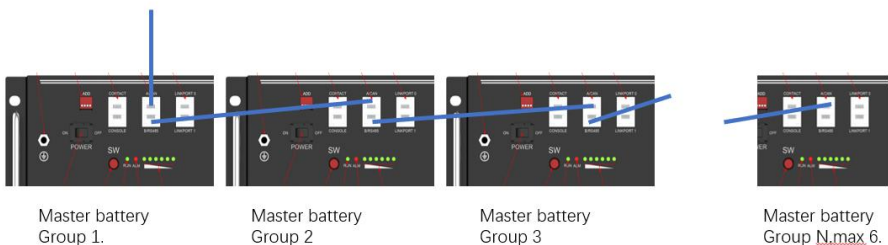

By CAN:

Connect power cable first:

- 1) each pair of cable hold max 120A constant current. Connect enough pairs of cable based on calculation of system current.
- 2) Suitable protection breaker between battery system and inverter is required.
- 3) connect power cable of LV-HUB

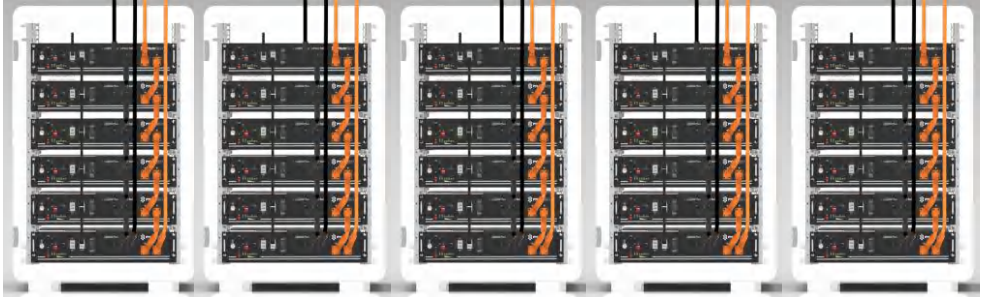

- 4) Make sure all dipswitch is X0XX, then turn ON batteries.
- 5) After all batteries running and buzzer of master battery in group1 rings 3 times. Means all groups are online.
- 6) Change the dip switch of **master battery in group1** to X1XX. Then connect communication cable between LV-HUB and master battery in group 1.
- 7) Then turn ON LV-HUB.

Detailed information please refer to manual of LV-HUB.

Multiple Battery Groups CAN Communication Cable Connection

Each Communication HUB connects maximum 6 battery piles.



- 1) The CAN IN connects to port 0
- 2) The A/CAN connects to port 1-7 freely
- 3) The B connect to A of next group: the B/RS485 of last group master battery is empty.



Each battery pile can configure maximum 16pcs US2000C/US3000C.

5. Trouble shooting.

Problem determination based on

- 1) Whether the battery can be turned on or not
- 2) If battery is turned on, check the red light is off, flashing or lighting
- 3) If the red light is off, check whether the battery can be charged/discharged or not.

Possible conditions:

- 1) Battery cannot turn on, switch ON and press the red SW the lights are all no lighting or flashing.
 - a) Capacity too low, or module over discharged.
solution: use a charge or inverter to provide 48-53.5V voltage. If battery can start, then keep charge the module and use monitor tools to check the battery log.
If battery terminal voltage is $\leq 45\text{Vdc}$, please use $\leq 0.05\text{C}$ to slowly charge the module to avoid affect to SOH.

If battery terminal voltage is $> 45\text{Vdc}$, it can use $\leq 0.5\text{C}$ to charge.

If battery cannot start, turn off battery and repair.
- 2) The battery can turn on, but red light is lighting, and cannot charge or discharge. If the red light is lighting, that means system is abnormal, please check values as following
 - b) Temperature: Above 60°C or under -10°C , the battery could not work.
Solution: to move battery to the normal operating temperature range between 0°C and 50°C
 - c) Current: If current exceeds 90A, battery protection will turn on.
Solution: Check whether current is too large or not, if it is, change the settings on power supply side.

- d) High Voltage: If charging voltage above 54V, battery protection will turn on.
Solution: Check whether voltage is too high or not, if it is, to change the settings on power supply side. And discharge the module.
 - e) Low Voltage: When the battery discharges to 44.5V or less, battery protection will turn on.
Solution: Charge the battery till the red light turns off.
 - f) Cell voltage high. The module voltage is lower than 54V, SOC LED does not all on. When discharge the module protection disappear.
Solution: keep charge the module by 53-54V or keep the system cycle. The BMS can balance the cell during cycling.
- 3) Unable to charge and discharge with red LED on. The temperature is 0~50 degree. Use charger to charge, not possible. Use load to discharge, not possible.
- g) Under permanent protection. The single cell voltage has been higher than 4.2 or lower than 1.5 or temperature higher than 80 degrees. Solution: Switch off the module and contact your local distributor for repair.
- 4) Unable to charge and discharge without red LED on. The temperature is 0~50 degree. Use charger to charge, not possible. Use load to discharge, not possible.
- h) Fuse broken.
Solution: Switch off the module and contact your local distributor for repair.



Caution

Buzzers indicate high risk faulty condition

- 5) Buzzer rings.
- i) Reverse connection of cables.
Solution: Power off all battery and inverters. Disconnect breaker. Check the cable connection and disconnect all power cables. Check the power port damaged or not.

then try turn on the single module, without any cable connected. If no alarm, then it is reverse connection of cables. Switch off the module and contact your local distributor.

j) MOSFAIL.

Solution: Power off all battery and inverters. Disconnect breaker. Check the cable connection and disconnect all power cables. Check the power port damaged or not.

then try turn on the single module, without any cable connected. If still buzzer rings. Then it is mosfail. Switch off the module and contact your local distributor.

6) After switch On, the module turns on directly

k) BMS failure.

Solution : Switch off the module and contact your local distributor.

Excluding the points above, if the faulty is still cannot be located, turn off battery and repair.

6. Emergency Situations

1) Leaking Batteries

If the battery pack leaks electrolyte, avoid contact with the leaking liquid or gas. If one is exposed to the leaked substance, immediately perform the actions described below.

- a) Inhalation: Evacuate the contaminated area and seek medical attention.
- b) Contact with eyes: Rinse eyes with flowing water for 15 minutes and seek medical attention.
- c) Contact with skin: Wash the affected area thoroughly with soap and water and seek medical attention.

Ingestion: Induce vomiting and seek medical attention.

2) Fire

NO WATER! Only dry powder fire or carbon dioxide extinguisher can be used; if possible, move the battery pack to a safe area before it catches fire.

3) Wet Batteries

If the battery pack is wet or submerged in water, do not let people access it, and then contact Pylontech or an authorized dealer for technical support. Cut off all power switch on inverter side.

4) Damaged Batteries

Damaged batteries are dangerous and must be handled with the utmost care. They are not fit for use and may pose a danger to people or property. If the battery pack seems to be damaged, pack it in its original container, and then return it to Pylontech or an authorized dealer.



Caution

Damaged batteries may leak electrolyte or produce flammable gas.

7. Remarks

Recycle and disposal

In case a battery (normal condition or damaged) needs disposal or needs recycling, it shall follow the local recycling regulation (i.e. Regulation (EC) N° 1013/2006 among European Union) to process, and using the best available techniques to achieve a relevant recycling efficiency.

Maintenance

- 1) It is required to charge the battery at least once every 6 months, for this charge maintenance make sure the SOC is charged to higher than 90%
- 2) Every year after installation. The connection of power connector, grounding point, power cable and screw are suggested to be checked. Make sure there is no loose, no broken, no corrosion at connection point. Check the installation environment such as dust, water, insect etc. make sure it is suitable for IP20 battery system.
- 3) If the battery is stored for long time, it is required to charge them every six months, and the SOC should be higher than 90%



PYLONTECH

Pylon Technologies Co., Ltd.

No. 73, Lane 887, ZuChongzhi Road, Zhangjiang Hi-Tech Park
Pudong, Shanghai 201203, China

T+86-21-51317699 | **F** +86-21-51317698

E service@pylontech.com.cn

W www.pylontech.com.cn