

User Manual

6.5KW / 8KW SOLAR INVERTER / CHARGER

Table of Contents

| | |
|--|-----------|
| ABOUT THIS MANUAL | 1 |
| Purpose..... | 1 |
| Scope..... | 1 |
| SAFETY INSTRUCTIONS | 1 |
| INTRODUCTION | 2 |
| Features..... | 2 |
| Basic System Architecture | 2 |
| Product Overview..... | 3 |
| Unpacking and Inspection | 4 |
| Mounting the Unit..... | 4 |
| Preparation | 5 |
| Battery Connection | 5 |
| AC Input/Output Connection..... | 6 |
| PV Connection | 8 |
| Final Assembly..... | 10 |
| DC Output Connectors..... | 10 |
| Communication Connection..... | 11 |
| Dry Contact Signal..... | 12 |
| OPERATION | 13 |
| Power ON/OFF | 13 |
| Operation and Display Panel | 13 |
| LCD Display Icons | 14 |
| LCD Setting..... | 16 |
| LCD Display | 32 |
| Operating Mode Description | 38 |
| Faults Reference Code | 42 |
| Warning Indicator | 43 |
| CLEARANCE AND MAINTENANCE FOR ANTI-DUST KIT | 44 |
| Overview | 44 |
| Clearance and Maintenance..... | 44 |
| BATTERY EQUALIZATION | 45 |
| SPECIFICATIONS | 46 |
| Table 1 Line Mode Specifications | 46 |
| Table 2 Inverter Mode Specifications | 47 |
| Table 3 Charge Mode Specifications..... | 48 |
| Table 4 General Specifications..... | 49 |
| TROUBLE SHOOTING | 50 |
| Appendix I: Parallel function | 51 |
| Appendix II: BMS Communication Installation | 64 |
| Appendix III: The Wi-Fi Operation Guide | 72 |

ABOUT THIS MANUAL

Purpose

This manual describes the assembly, installation, operation and troubleshooting of this unit. Please read this manual carefully before installations and operations. Keep this manual for future reference.

Scope

This manual provides safety and installation guidelines as well as information on tools and wiring.

SAFETY INSTRUCTIONS

⚠ WARNING: This chapter contains important safety and operating instructions. Read and keep this manual for future reference.

1. Before using the unit, read all instructions and cautionary markings on the unit, the batteries and all appropriate sections of this manual.
2. **CAUTION** – To reduce risk of injury, charge only deep-cycle lead acid type rechargeable batteries. Other types of batteries may burst, causing personal injury and damage.
3. Do not disassemble the unit. Take it to a qualified service center when service or repair is required. Incorrect re-assembly may result in a risk of electric shock or fire.
4. To reduce risk of electric shock, disconnect all wirings before attempting any maintenance or cleaning. Turning off the unit will not reduce this risk.
5. **CAUTION** – Only qualified personnel can install this device with battery.
6. **NEVER** charge a frozen battery.
7. For optimum operation of this inverter/charger, please follow required spec to select appropriate cable size. It's very important to correctly operate this inverter/charger.
8. Be very cautious when working with metal tools on or around batteries. A potential risk exists to drop a tool to spark or short circuit batteries or other electrical parts and could cause an explosion.
9. Please strictly follow installation procedure when you want to disconnect AC or DC terminals. Please refer to INSTALLATION section of this manual for the details.
10. Fuses are provided as over-current protection for the battery supply.
11. **GROUNDING INSTRUCTIONS** -This inverter/charger should be connected to a permanent grounded wiring system. Be sure to comply with local requirements and regulation to install this inverter.
12. **NEVER** cause AC output and DC input short circuited. Do NOT connect to the mains when DC input short circuits.
13. **Warning!!** Only qualified service persons are able to service this device. If errors still persist after following troubleshooting table, please send this inverter/charger back to local dealer or service center for maintenance.
14. **WARNING:** Because this inverter is non-isolated, only three types of PV modules are acceptable: single crystalline, poly crystalline with class A-rated and CIGS modules. To avoid any malfunction, do not connect any PV modules with possible current leakage to the inverter. For example, grounded PV modules will cause current leakage to the inverter. When using CIGS modules, please be sure NO grounding.
15. **CAUTION:** It's required to use PV junction box with surge protection. Otherwise, it will cause damage on inverter when lightning occurs on PV modules.

INTRODUCTION

This is a multi-function inverter, combining functions of inverter, solar charger and battery charger to offer uninterruptible power support in a single package. The comprehensive LCD display offers user-configurable and easy-accessible button operations such as battery charging current, AC or solar charging priority, and acceptable input voltage based on different applications.

Features

- Pure sine wave inverter
- Customizable status LED ring with RGB lights
- Touchable button with 5" colored LCD
- Built-in Wi-Fi for mobile monitoring (APP is required)
- Supports USB On-the-Go function
- Built-in anti-dusk kit
- Reserved communication ports for BMS (RS485, CAN-BUS, RS232)
- Configurable input voltage ranges for home appliances and personal computers via LCD control panel
- Configurable output usage timer and prioritization
- Configurable charger source priority via LCD control panel
- Configurable battery charging current based on applications via LCD control panel
- Compatible to utility mains or generator power

Basic System Architecture

The following illustration shows basic application for this unit. It also required the following devices to have a complete running system:

- Generator or Utility mains.
- PV modules

Consult with your system integrator for other possible system architectures depending on your requirements.

This inverter can power various appliances in home or office environment, including motor-type appliances such as tube light, fan, refrigerator and air conditioners.

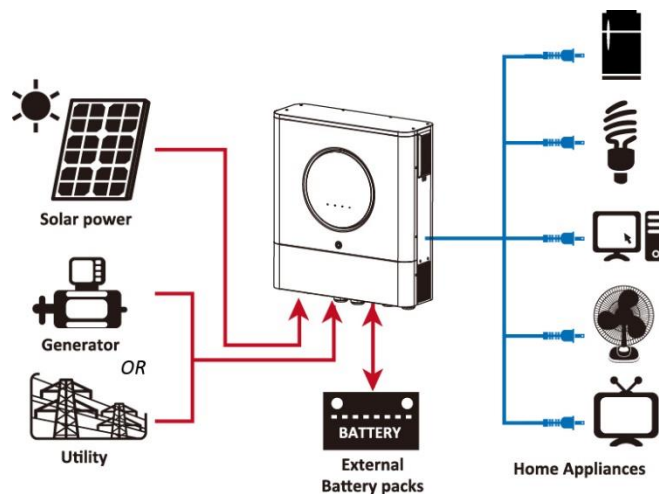
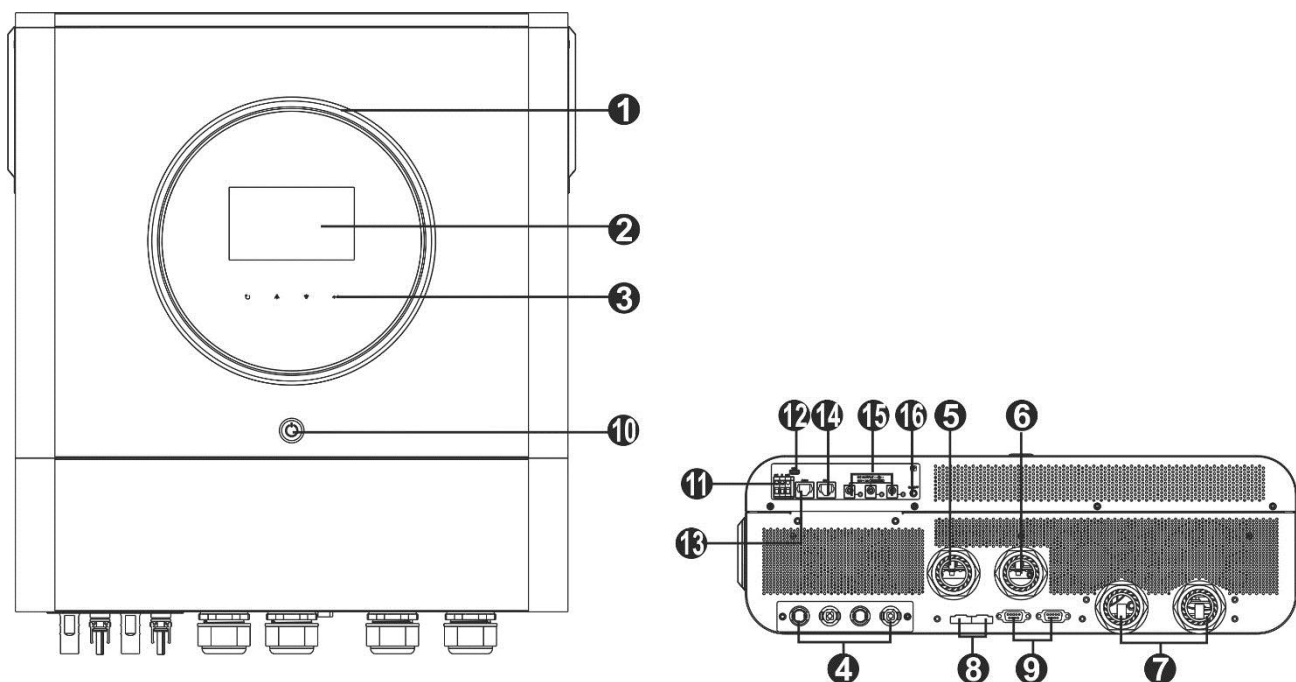

Figure 1 Basic hybrid PV System Overview

Product Overview



NOTE: For parallel installation and operation, please check *Appendix I*.

1. RGB LED ring (refer to LCD Setting section for the details)
2. LCD display
3. Touchable function keys
4. PV connectors
5. AC input connectors
6. AC output connectors (Load connection)
7. Battery connectors
8. Current sharing port
9. Parallel communication port
10. Power switch
11. Dry contact
12. USB port as USB communication port and USB function port
13. RS-232 communication port
14. BMS communication port: CAN, RS-485 or RS-232
15. DC output connectors
16. Power switch for DC output

INSTALLATION

Unpacking and Inspection

Before installation, please inspect the unit. Be sure that nothing inside the package is damaged. You should have received the following items inside of package:

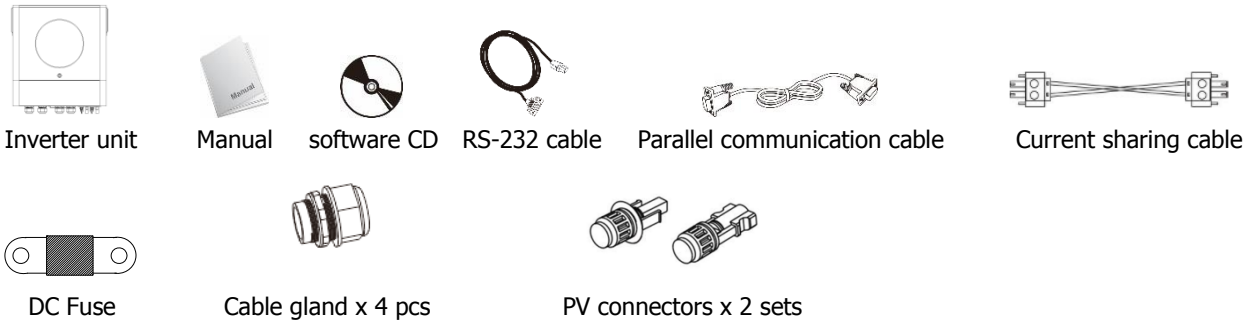

Mounting the Unit

Consider the following points before selecting where to install:

- Do not mount the inverter on flammable construction materials.
- Mount on a solid surface
- Install this inverter at eye level in order to allow the LCD display to be read at all times.
- The ambient temperature should be between 0°C and 55°C to ensure optimal operation.
- The recommended installation position is to be adhered to the wall vertically.
- Be sure to keep other objects and surfaces as shown in the right diagram to guarantee sufficient heat dissipation and to have enough space for removing wires.

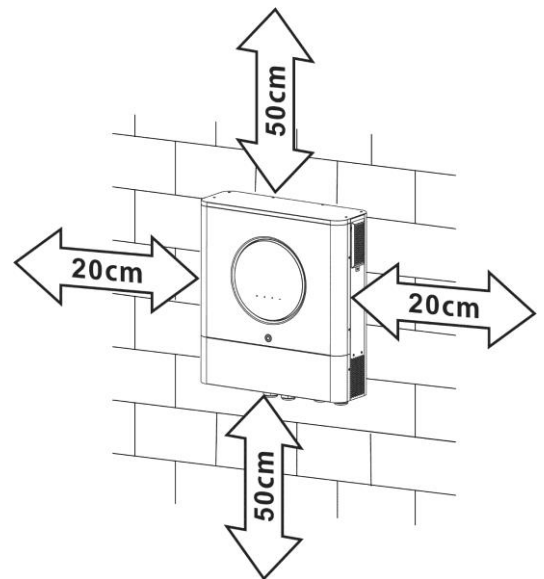

⚠ SUITABLE FOR MOUNTING ON CONCRETE OR OTHER NON-COMBUSTIBLE SURFACE ONLY.

Please follow below steps to install the inverter on the wall.

| | | |
|--|---|---|
| <p>Step 1: Install the bracket by screwing four M5 screws.</p> | <p>Step 2: Install the mounting ears on the back of the unit with four M5 screws.</p> | <p>Step 3: Raise the inverter and place it over the mounting bracket.</p> |
| <p>M5 screw x 4pcs</p> <p>WALL</p> | <p>M5 screw x 4pcs</p> <p>Mounting Ear 2pcs</p> <p>WALL</p> | <p>WALL</p> |

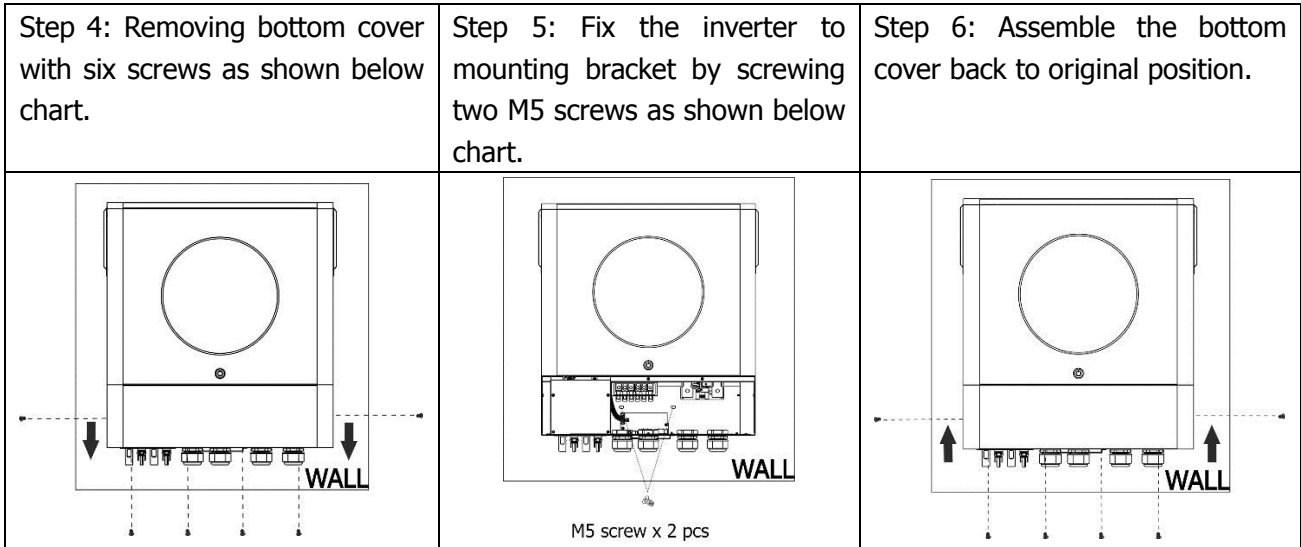

Preparation

Before connecting all wirings, please take off wiring cover by removing six screws. When removing the bottom cover, be carefully to remove two cables as shown below.

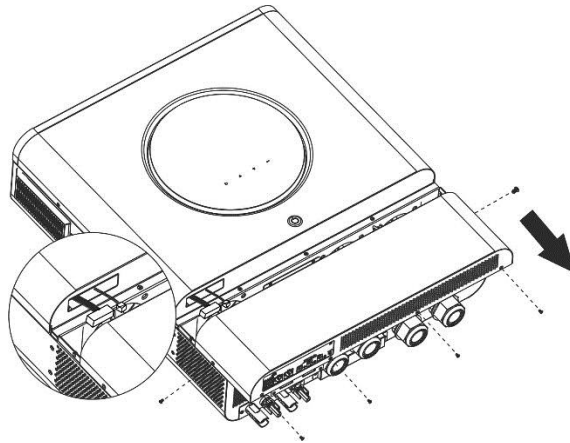

Battery Connection

CAUTION: For safety operation and regulation compliance, it's requested to install a separate DC over-current protector or disconnect device between battery and inverter. It may not be requested to have a disconnect device in some applications, however, it's still requested to have over-current protection installed. Please refer to typical amperage in below table as required fuse or breaker size.

WARNING! All wiring must be performed by a qualified personnel.

WARNING! It's very important for system safety and efficient operation to use appropriate cable for battery connection. To reduce risk of injury, please use the proper recommended cable and terminal size as below.

Ring terminal:

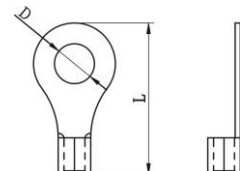

Recommended battery cable and terminal size:

| Model | Typical Amperage | Battery capacity | Wire Size | Cable mm ² | Ring Terminal Dimensions | | Torque value |
|-------|------------------|------------------|-----------|-----------------------|--------------------------|--------|--------------|
| | | | | | D (mm) | L (mm) | |
| | | | | | 6.5KW | 153A | |
| 8KW | 182.2A | 250AH | 1*2/0AWG | 67.4 | 8.4 | 51 | 5 Nm |

Please follow below steps to implement battery connection:

1. Assemble battery ring terminal based on recommended battery cable and terminal size.
2. Fix two cable glands into positive and negative terminals.
3. Insert the ring terminal of battery cable flatly into battery connector of inverter and make sure the nuts are tightened with torque of 5 Nm. Make sure polarity at both the battery and the inverter/charge is correctly connected and ring terminals are tightly screwed to the battery terminals.

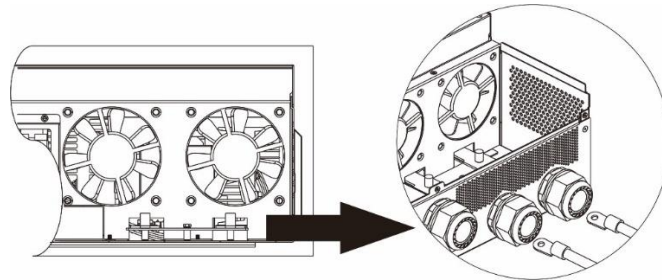

WARNING: Shock Hazard

Installation must be performed with care due to high battery voltage in series.



CAUTION!! Do not place anything between the flat part of the inverter terminal and the ring terminal. Otherwise, overheating may occur.

CAUTION!! Do not apply anti-oxidant substance on the terminals before terminals are connected tightly.

CAUTION!! Before making the final DC connection or closing DC breaker/disconnector, be sure positive (+) must be connected to positive (+) and negative (-) must be connected to negative (-).

AC Input/Output Connection

CAUTION!! Before connecting to AC input power source, please install a **separate** AC breaker between inverter and AC input power source. This will ensure the inverter can be securely disconnected during maintenance and fully protected from over current of AC input.

CAUTION!! There are two terminal blocks with "IN" and "OUT" markings. Please do NOT mis-connect input and output connectors.

WARNING! All wiring must be performed by a qualified personnel.

WARNING! It's very important for system safety and efficient operation to use appropriate cable for AC input connection. To reduce risk of injury, please use the proper recommended cable size as below.

Suggested cable requirement for AC wires

| Model | Gauge | Torque Value |
|-------|-------|--------------|
| 6.5KW | 4 AWG | 1.4~ 1.6Nm |
| 8KW | 8 AWG | 1.4~ 1.6Nm |

Please follow below steps to implement AC input/output connection:

1. Before making AC input/output connection, be sure to open DC protector or disconnector first.
2. Remove insulation sleeve 10mm for six conductors. And shorten phase L and neutral conductor N 3 mm.
3. Fix two cable glands into input and output sides.
4. Insert AC input wires according to polarities indicated on terminal block and tighten the terminal screws.

Be sure to connect PE protective conductor (⊕) first.



→ **Ground (yellow-green)**

L → **LINE (brown or black)**

N → **Neutral (blue)**

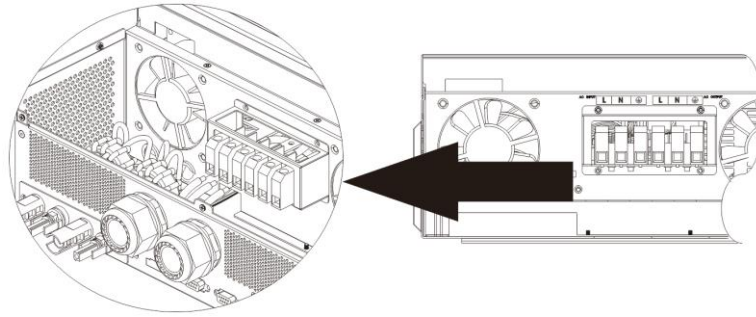

WARNING:

Be sure that AC power source is disconnected before attempting to hardwire it to the unit.

5. Then, insert AC output wires according to polarities indicated on terminal block and tighten terminal screws. Be sure to connect PE protective conductor (⊕) first.



→ **Ground (yellow-green)**

L → **LINE (brown or black)**

N → **Neutral (blue)**

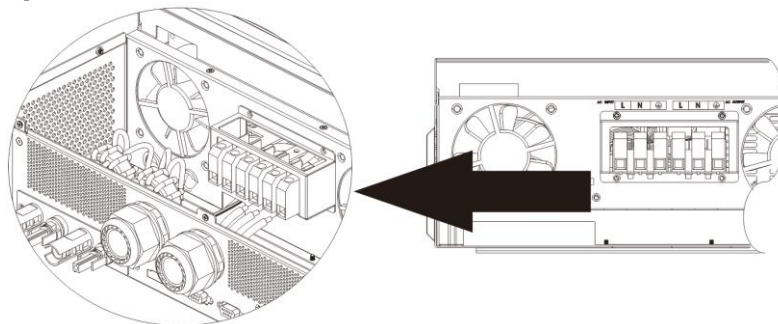

6. Make sure the wires are securely connected.

CAUTION: Important

Be sure to connect AC wires with correct polarity. If L and N wires are connected reversely, it may cause utility short-circuited when these inverters are worked in parallel operation.

CAUTION: Appliances such as air conditioner requires at least 2~3 minutes to restart because it's required to have enough time to balance refrigerant gas inside of circuits. If a power shortage occurs and recovers in a short time, it will cause damage to your connected appliances. To prevent this kind of damage, please check manufacturer of air conditioner if it's equipped with time-delay function before installation. Otherwise, this inverter/charger will be trigger overload fault and cut off output to protect your appliance but sometimes it still causes internal damage to the air conditioner.

PV Connection

CAUTION: Before connecting to PV modules, please install **separately** DC circuit breakers between inverter and PV modules.

NOTE1: Please use 600VDC/30A circuit breaker.

NOTE2: The overvoltage category of the PV input is II.

Please follow the steps below to implement PV module connection:

WARNING: Because this inverter is non-isolated, only three types of PV modules are acceptable: single crystalline and poly crystalline with class A-rated and CIGS modules.
 To avoid any malfunction, do not connect any PV modules with possible current leakage to the inverter. For example, grounded PV modules will cause current leakage to the inverter. When using CIGS modules, please be sure NO grounding.
CAUTION: It's required to use PV junction box with surge protection. Otherwise, it will cause damage on inverter when lightning occurs on PV modules.





Step 1: Check the input voltage of PV array modules. This system is applied with two strings of PV array. Please make sure that the maximum current load of each PV input connector is 18A.

CAUTION: Exceeding the maximum input voltage can destroy the unit!! Check the system before wire connection.

Step 2: Disconnect the circuit breaker and switch off the DC switch.

Step 3: Assemble provided PV connectors with PV modules by the following steps.

Components for PV connectors and Tools:

| | |
|---------------------------|---|
| Female connector housing |  |
| Female terminal |  |
| Male connector housing |  |
| Male terminal |  |
| Crimping tool and spanner |  |

Prepare the cable and follow the connector assembly process:

Strip one cable 8 mm on both end sides and be careful NOT to nick conductors.

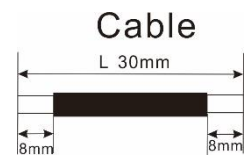

Insert striped cable into female terminal and crimp female terminal as shown below.



Insert assembled cable into female connector housing as shown below.



Insert striped cable into male terminal and crimp male terminal as shown below.



Insert assembled cable into male connector housing as shown below.



Then, use spanner to screw pressure dome tightly to female connector and male connector as shown below.



Step 4: Check correct polarity of connection cable from PV modules and PV input connectors. Then, connect positive pole (+) of connection cable to positive pole (+) of PV input connector. Connect negative pole (-) of connection cable to negative pole (-) of PV input connector.

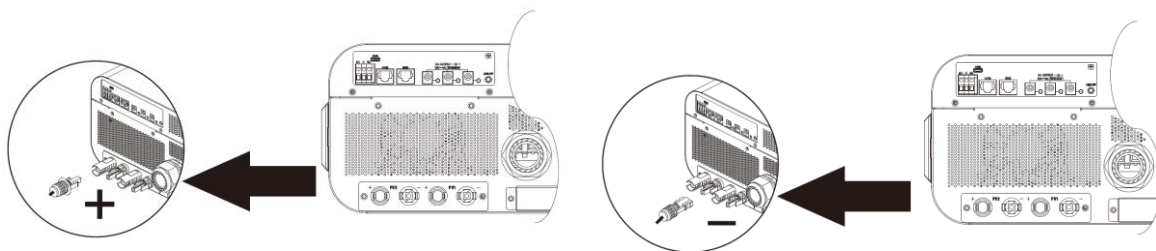

WARNING! For safety and efficiency, it's very important to use appropriate cables for PV module connection. To reduce risk of injury, please use the proper cable size as recommended below.

| Model | Wire Size | Cable mm ² |
|-------|-----------|-----------------------|
| 8KW | 10~12 AWG | 4~6 |

CAUTION: Never directly touch the terminals of inverter. It might cause lethal electric shock.

Recommended Panel Configuration

When selecting proper PV modules, please be sure to consider the following parameters:

1. Open circuit Voltage (Voc) of PV modules not to exceed maximum PV array open circuit voltage of the inverter.
2. Open circuit Voltage (Voc) of PV modules should be higher than the start-up voltage.

| INVERTER MODEL | 6.5KW | 8KW |
|------------------------------------|--------------|--------------|
| Max. PV Array Power | 8000W | |
| Max. PV Array Open Circuit Voltage | 250Vdc | 500Vdc |
| PV Array MPPT Voltage Range | 90Vdc~230Vdc | 90Vdc~450Vdc |
| Start-up Voltage (Voc) | 80Vdc | |

Recommended solar panel configuration for 6.5KW model:

| Solar Panel Spec. (reference) | SOLAR INPUT 1 | SOLAR INPUT 2 | Q'ty of panels | Total Input Power |
|----------------------------------|---|---------------------------|----------------|-------------------|
| | Min in series: 3pcs, per input Max. in series: 6pcs, per input | | | |
| - 330Wp | 3pcs in series | x | 3pcs | 990W |
| - Vmp: 33.7Vdc | x | 3pcs in series | 3pcs | 990W |
| - Imp: 9.79A | 6pcs in series | x | 6pcs | 1980W |
| - Voc: 39.61Vdc | x | 6pcs in series | 6pcs | 1980W |
| - Isc: 10.4A | 6pcs in series | 6pcs in series | 12pcs | 3960W |
| - Cells: 60 | 6pcs in series, 2 strings | x | 12pcs | 3960W |
| | x | 6pcs in series, 2 strings | 12pcs | 3960W |
| | 6pcs in series, 2 strings | 6pcs in series, 2 strings | 24pcs | 7920W |

Recommended solar panel configuration for 8KW model:

| Solar Panel Spec. (reference) | SOLAR INPUT 1 | SOLAR INPUT 2 | Q'ty of panels | Total Input Power |
|----------------------------------|--|---------------------------|----------------|-------------------|
| | Min in series: 4pcs, per input Max. in series: 12pcs, per input | | | |
| - 250Wp | 4pcs in series | x | 4pcs | 1000W |
| - Vmp: 30.7Vdc | x | 4pcs in series | 4pcs | 1000W |
| - Imp: 8.3A | 12pcs in series | x | 12pcs | 3000W |
| - Voc: 37.7Vdc | x | 12pcs in series | 12pcs | 3000W |
| - Isc: 8.4A | 6pcs in series | 6pcs in series | 12pcs | 3000W |
| - Cells: 60 | 6pcs in series, 2 strings | x | 12pcs | 3000W |
| | x | 6pcs in series, 2 strings | 12pcs | 3000W |
| | 8pcs in series, 2 strings | x | 16pcs | 4000W |
| | x | 8pcs in series, 2 strings | 16pcs | 4000W |
| | 9pcs in series, 1 string | 9pcs in series, 1 string | 18pcs | 4500W |
| | 10pcs in series, 1 string | 10pcs in series, 1 string | 20pcs | 5000W |
| | 12pcs in series, 1 string | 12pcs in series, 1 string | 24pcs | 6000W |
| | 6pcs in series, 2 strings | 6pcs in series, 2 strings | 24pcs | 6000W |
| | 7pcs in series, 2 strings | 7pcs in series, 2 strings | 28pcs | 7000W |
| | 8pcs in series, 2 strings | 8pcs in series, 2 strings | 32pcs | 8000W |

Final Assembly

After connecting all wirings, re-connect two cables and then put bottom cover back by fixing six screws as shown below.

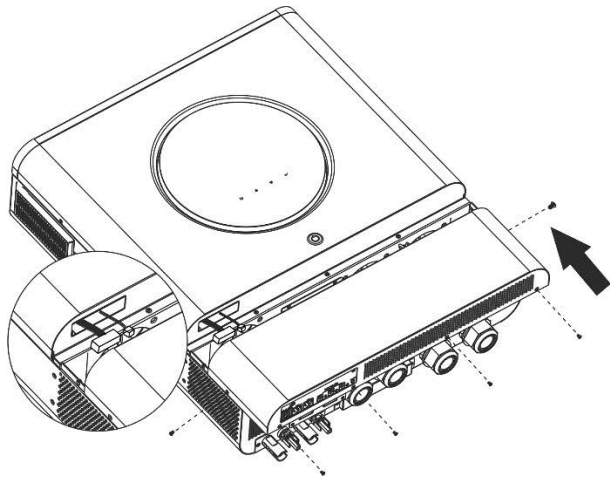

DC Output Connectors

These DC output connectors are used to provide emergency power backup to all kinds of DC-powered equipment such as routers, modems, set-top box, VOIP phone systems, surveillance system, alarm system, access control system and many critical telecom equipment. There are 3 channels (current limit at 3A for each channel), which could be activated/disabled manually either through LCD operation or power switch beside the DC jacks.

Supplied dimension of DC jack (male) is OD 5.5mm, ID 2.5mm.

Communication Connection

Follow below chart to connect all communication wiring.

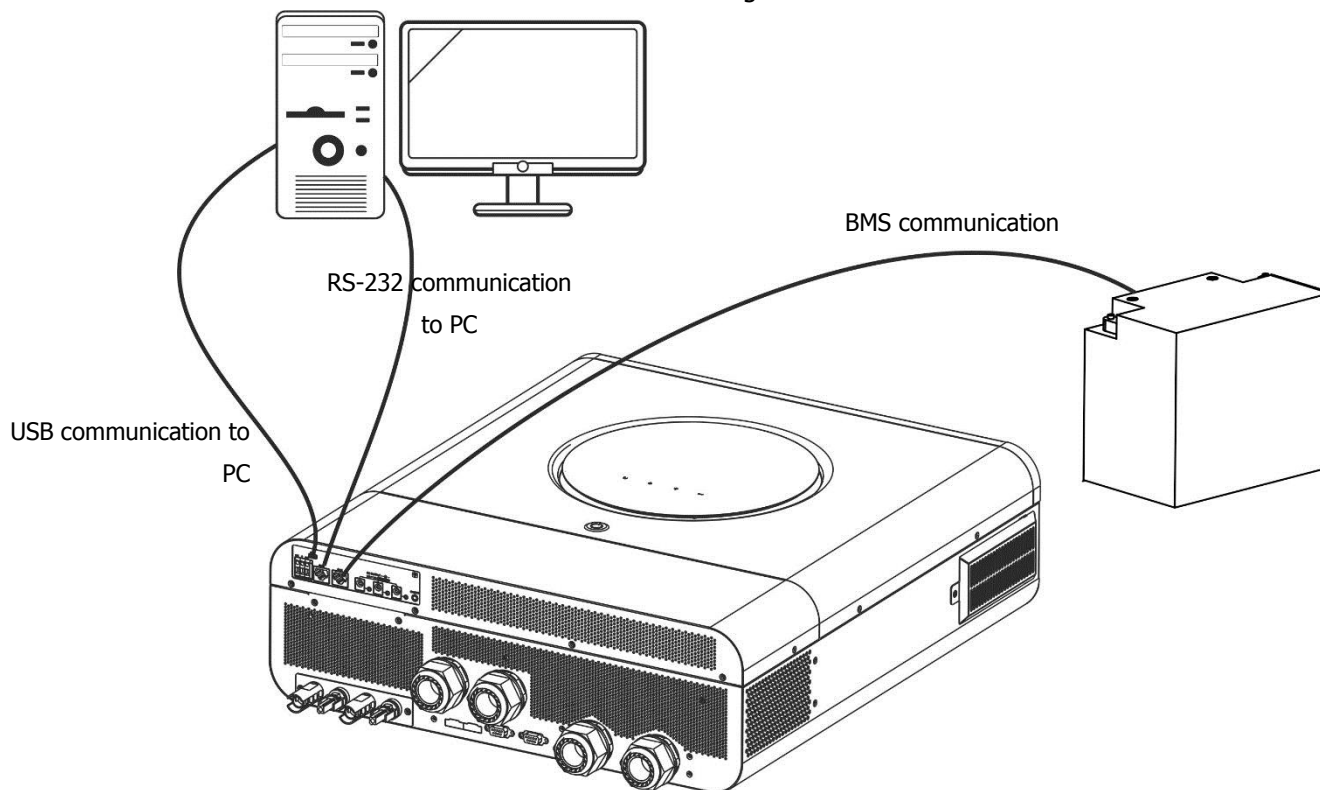

Serial Connection

Please use the supplied serial cable to connect between the inverter and your PC. Install the monitoring software from the bundled CD and follow the on-screen instructions to complete your installation. For detailed software operation, refer to the software user manual on the bundled CD.

Wi-Fi Connection

This unit is equipped with a Wi-Fi transmitter. Wi-Fi transmitter can enable wireless communication between off-grid inverters and monitoring platform. Users can access and control the monitored inverter with downloaded APP. You may find "WatchPower" app from the Apple® Store or "WatchPower Wi-Fi" in Google® Play Store. All data loggers and parameters are saved in iCloud. For quick installation and operation, please refer to Appendix III - The Wi-Fi Operation Guide for details.

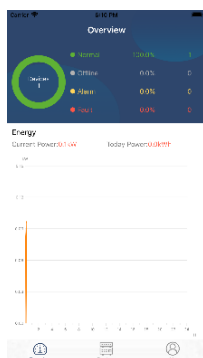

BMS Communication Connection

It is recommended to purchase a special communication cable if you are connecting to Lithium-Ion battery banks. Please refer to Appendix II - BMS Communication Installation for details.

Dry Contact Signal

There is one dry contact (3A/250VAC) available on the rear panel. It could be used to deliver signal to external device when battery voltage reaches warning level.

| Unit Status | Condition | | |  Dry contact port: NC C NO | |
|-------------|---|--|--|--|--------|
| | | | | NC & C | NO & C |
| Power Off | Unit is off and no output is powered. | | | Close | Open |
| Power On | Output is powered from Battery power or Solar energy. | Program 01 set as USB (utility first) or SUB (solar first) | Battery voltage < Low DC warning voltage | Open | Close |
| | | | Battery voltage > Setting value in Program 13 or battery charging reaches floating stage | Close | Open |
| | | Program 01 is set as SBU (SBU priority) | Battery voltage < Setting value in Program 12 | Open | Close |
| | | | Battery voltage > Setting value in Program 13 or battery charging reaches floating stage | Close | Open |

OPERATION

Power ON/OFF

Once the unit has been properly installed and the batteries are connected well, simply press power switch to turn on the unit.

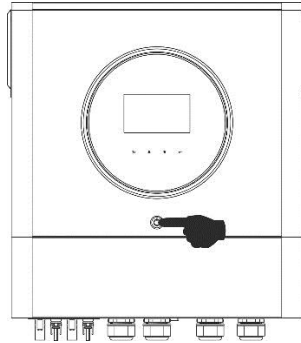

Operation and Display Panel

The operation and the LCD module, shown in the chart below, includes one RGB LED ring, one power switch, four touchable function keys and a LCD display to indicate the operating status and input/output power information.

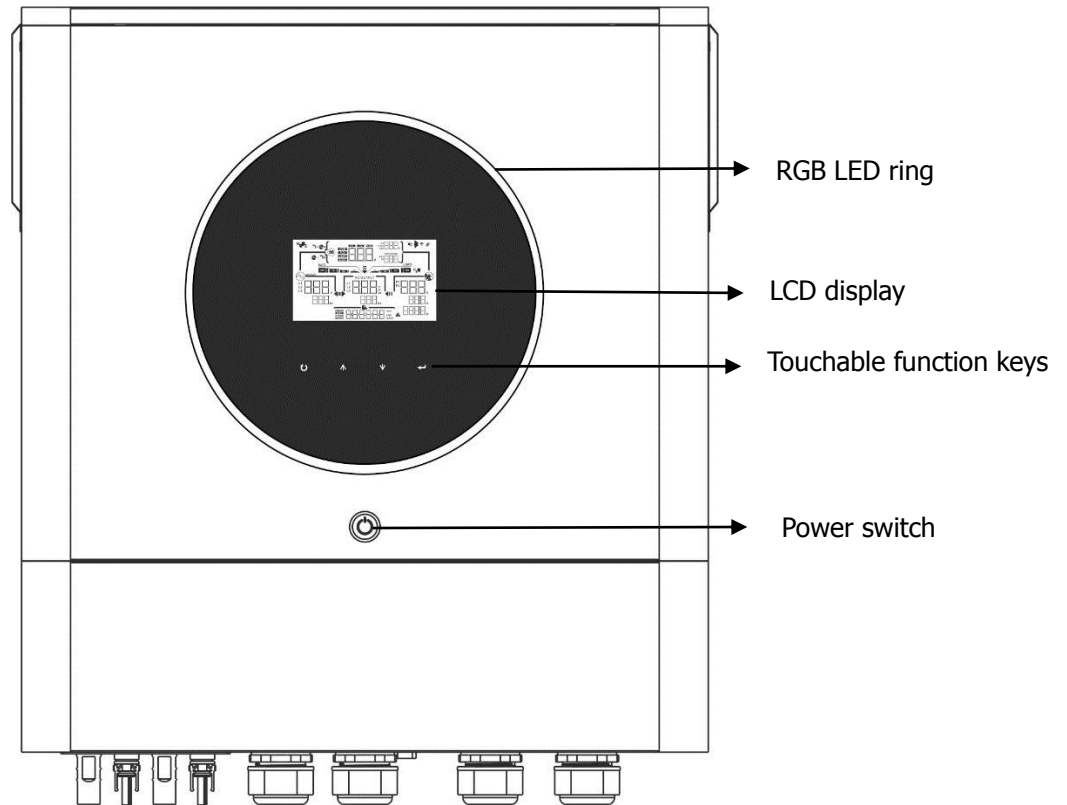







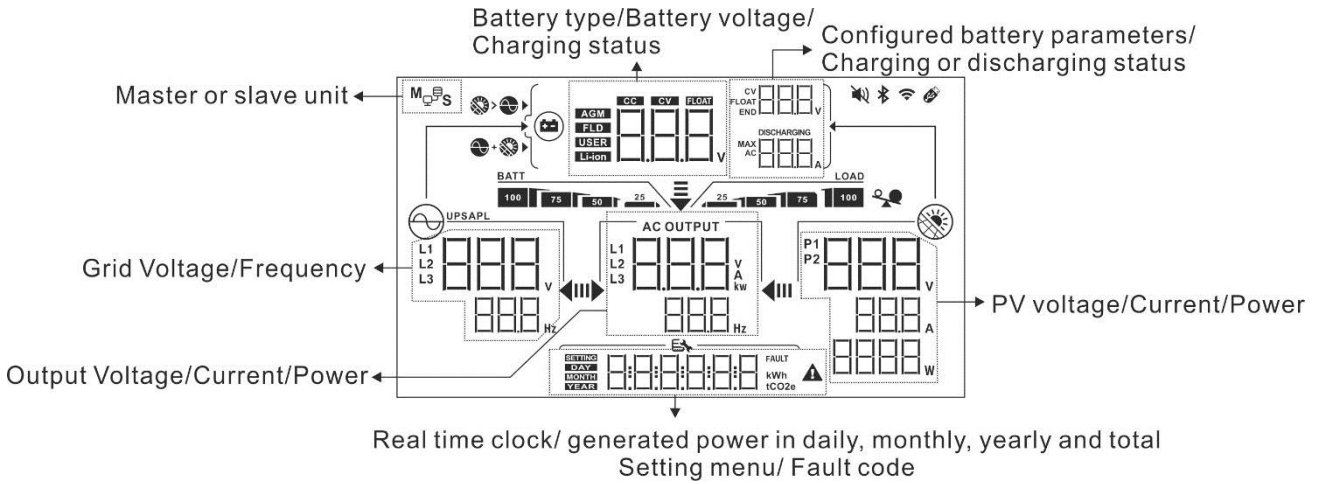



Touchable Function Keys

| Function Key | | Description |
|--------------|-------------------------|--|
| ↻ | ESC | To exit the setting |
| | Access USB setting mode | To enter USB setting mode |
| ▲ | Up | To last selection |
| ▼ | Down | To next selection |
| ↵ | Enter | To confirm/enter the selection in setting mode |

LCD Display Icons



| Battery Information | | |
|--|--|---|
| BATT Indicates battery level by 0-24%, 25-49%, 50-74% and 75-100% in battery mode and charging status in line mode. | | |
| When battery is charging, it will present battery charging status. | | |
| Status | Battery voltage | LCD Display |
| C.C. mode C.V. mode | <2V/cell | 4 bars will flash in turns. |
| | 2 ~ 2.083V/cell | The right bar will be on and the other three bars will flash in turns. |
| | 2.083 ~ 2.167V/cell | The right two bars will be on and the other two bars will flash in turns. |
| | > 2.167 V/cell | The right three bars will be on and the left bar will flash. |
| Floating mode. Batteries are fully charged. | | 4 bars will be on. |
| In battery mode, it will present battery capacity. | | |
| Load Percentage | Battery Voltage | LCD Display |
| Load >50% | < 1.85V/cell | |
| | 1.85V/cell ~ 1.933V/cell | |
| | 1.933V/cell ~ 2.017V/cell | |
| | > 2.017V/cell | |
| Load < 50% | < 1.892V/cell | |
| | 1.892V/cell ~ 1.975V/cell | |
| | 1.975V/cell ~ 2.058V/cell | |
| | > 2.058V/cell | |
| Load Information | | |
| | Indicates overload. | |
| | Indicates the load level by 0-24%, 25-49%, 50-74% and 75-100%. | |

| Charger Source Priority Setting Display | |
|---|---|
|  | Indicates setting program 16 "Charger source priority" is selected as "Solar first". |
|  | Indicates setting program 16 "Charger source priority" is selected as "Solar and Utility". |
|  | Indicates setting program 16 "Charger source priority" is selected as "Solar only". |
| Output source priority setting display | |
|  | Indicates setting program 01 "Output source priority" is selected as "Utility first". |
|  | Indicates setting program 01 "Output source priority" is selected as "Solar first". |
|  | Indicates setting program 01 "Output source priority" is selected as "SBU". |
| AC Input Voltage Range Setting Display | |
| UPS | Indicates setting program 03 is selected as "UPS". The acceptable AC input voltage range will be within 170-280VAC for 8KW and 90-140VAC for 6.5KW. |
| APL | Indicates setting program 03 is selected as "APL". The acceptable AC input voltage range will be within 90-280VAC for 8KW and 80-140VAC for 6.5KW. |
| Operation Status Information | |
|  | Indicates unit connects to the mains. |
|  | Indicates unit connects to the PV panel. |
| AGM FLD USER Li-ion | Indicates battery type. |
| M ₁ S | Indicates parallel operation is working. |
|  | Indicates unit alarm is disabled. |
|  | Indicates Wi-Fi transmission is working. |
|  | Indicates USB disk is connected. |

LCD Setting

General Setting



After pressing and holding “←” button for 3 seconds, the unit will enter the Setup Mode. Press “▲” or “▼” button to select setting programs. Press “←” button to confirm you selection or “↻” button to exit.

Setting Programs:

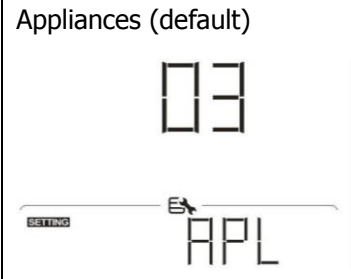
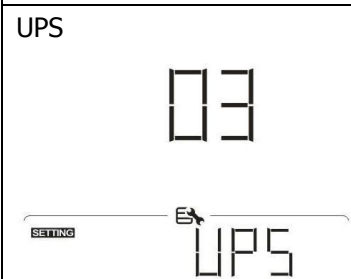
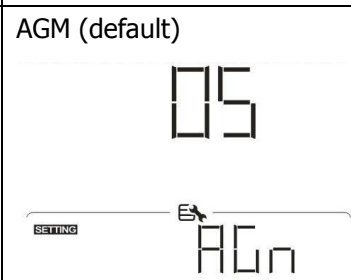
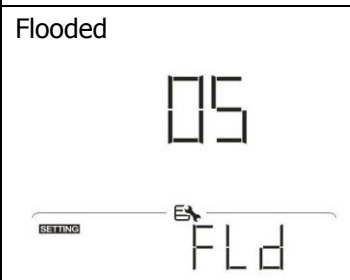
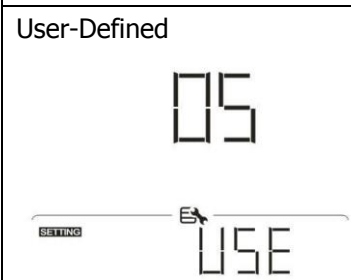
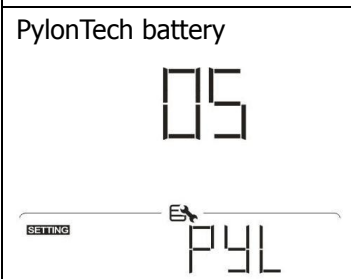
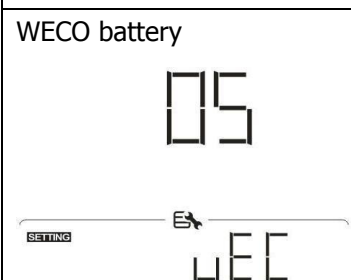
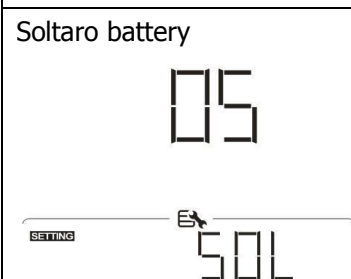
| Program | Description | Selectable option | |
|---------|---|-------------------------|---|
| 00 | Exit setting mode | Escape | |
| | | 00 | |
| | | | |
| 01 | Output source priority: To configure load power source priority | Utility first (default) | Utility will provide power to the loads as first priority. Solar and battery energy will provide power to the loads only when utility power is not available. |
| | | 01 | |
| | | | |
| | | Solar first | Solar energy provides power to the loads as first priority. If solar energy is not sufficient to power all connected loads, Utility energy will supply power to the loads at the same time. |
| | | 01 | |
| | | | |
| | | SBU priority | Solar energy provides power to the loads as first priority. If solar energy is not sufficient to power all connected loads, battery energy will supply power to the loads at the same time. Utility provides power to the loads only when battery voltage drops to either low-level warning voltage or the setting point in program 12. |
| | | 01 | |
| | | | |
| 02 | Maximum charging current: To configure total charging current for solar and utility chargers. (Max. charging current = utility charging current + solar charging current) | 60A (default) | Setting range is from 10A to 120A for 6.5KW model and from 10A to 150A for 8KW model. Increment of each click is 10A. |
| | | 02 | |
| | | | |

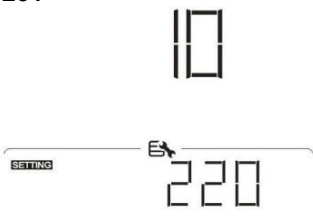
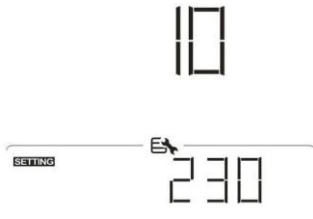
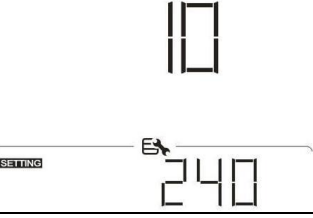

| | | | |
|----|------------------------|---|--|
| 03 | AC input voltage range | Appliances (default)  | If selected, acceptable AC input voltage range will be within 90-280VAC. |
| | | UPS  | If selected, acceptable AC input voltage range will be within 170-280VAC. |
| 05 | Battery type | AGM (default)  | Flooded  |
| | | User-Defined  | If "User-Defined" is selected, battery charge voltage and low DC cut-off voltage can be set up in program 26, 27 and 29. |
| | | PylonTech battery  | If selected, programs of 02, 26, 27 and 29 will be automatically set up. No need for further setting. |
| | | WECO battery  | If selected, programs of 02, 12, 26, 27 and 29 will be auto-configured per battery supplier recommended. No need for further adjustment. |
| | | Soltaro battery  | If selected, programs of 02, 26, 27 and 29 will be automatically set up. No need for further setting. |

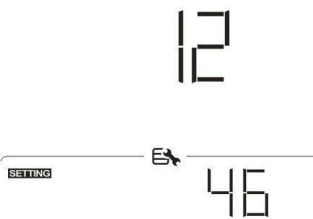
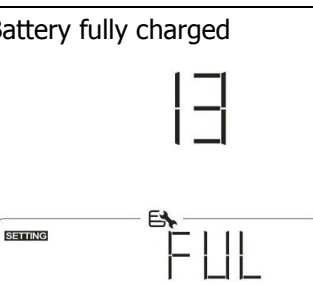
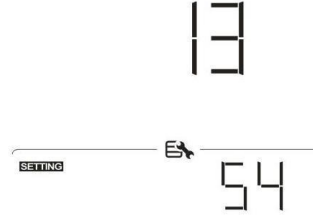
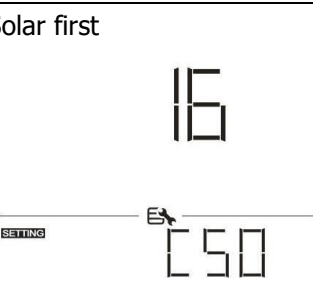

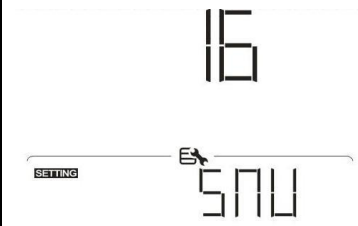
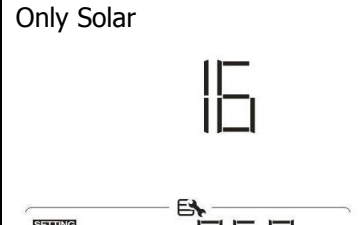
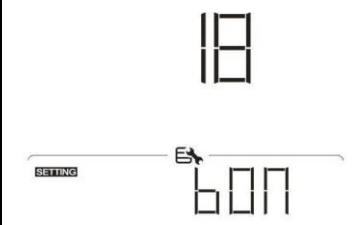
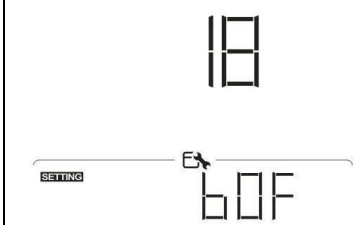
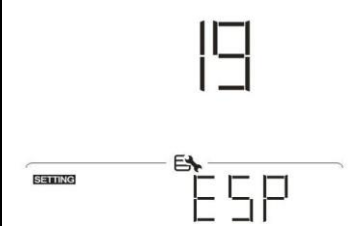
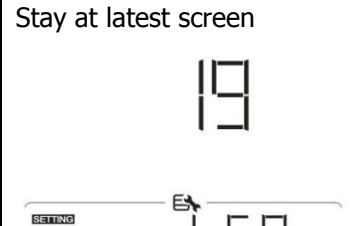
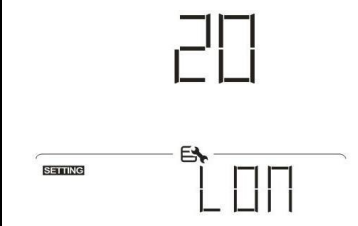
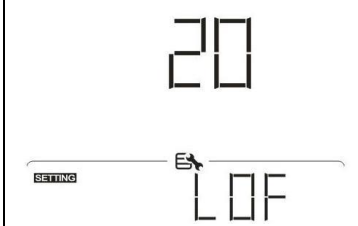
| | | | |
|----|-----------------------------------|---|---|
| 05 | Battery type | LIb-protocol compatible battery 05 | Select "LIb" if using Lithium battery compatible to Lib protocol. If selected, programs of 02, 26, 27 and 29 will be automatically set up. No need for further setting. |
| | | 3 rd party Lithium battery 05 | If selected, programs of 02, 26, 27 and 29 will be automatically set up. No need for further setting. Please contact the battery supplier for installation procedure. |
| 06 | Auto restart when overload occurs | Restart disable (default) 06 | Restart enable 06 |
| | | Restart disable (default) 07 | Restart enable 07 |
| 09 | Output frequency | 50Hz (default for 8KW model) 09 | 60Hz (default for 6.5KW model) 09 |
| 10 | Output voltage | Available options for 6.5KW model | |
| | | 110V 10 | 120V (default) 10 |
| | | 127V 10 | |

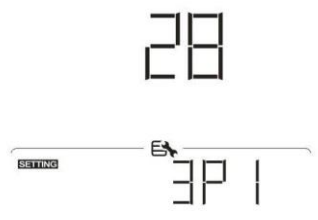
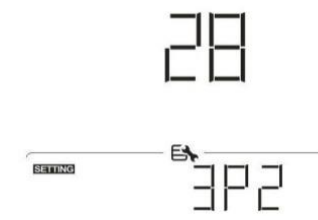
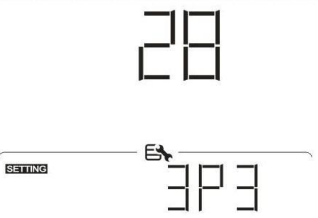
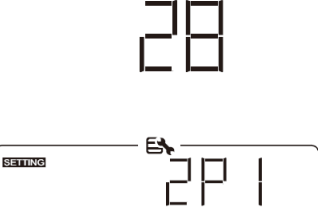
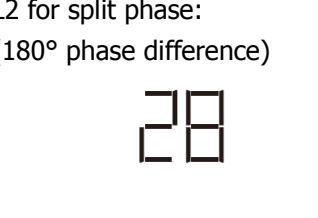

| | | | |
|----|---|--|--|
| 10 | Output voltage | Available options for 8KW model | |
| | | 220V  | 230V (default)  |
| 11 | Maximum utility charging current Note: If setting value in program 02 is smaller than that in program in 11, the inverter will apply charging current from program 02 for utility charger. | 240V  | |
| | | 30A (default)  | Setting range is from 2A, then 10A to 120A. Increment of each click is 10A. |
| 12 | Setting voltage point back to utility source when selecting "SBU" (SBU priority) in program 01. | 46V (default)  | Setting range is from 44V to 51V. Increment of each click is 1V. |
| 13 | Setting voltage point back to battery mode when selecting "SBU" (SBU priority) in program 01. | Setting range is FUL and from 48V to 62V. Increment of each click is 1V. | |
| | | Battery fully charged  | 54V (default)  |
| 16 | Charger source priority: To configure charger source priority | If this inverter/charger is working in Line, Standby or Fault mode, charger source can be programmed as below: | |
| | | Solar first  | Solar energy will charge battery as first priority. Utility will charge battery only when solar energy is not available. |

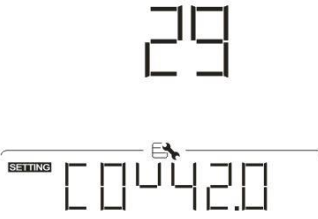

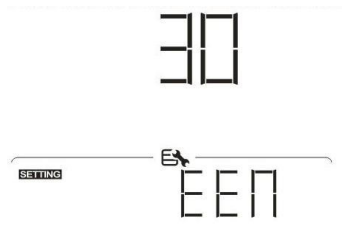
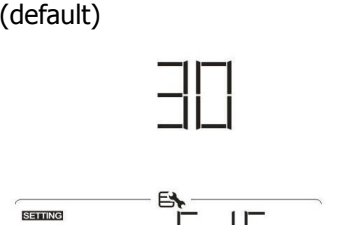
| | | | |
|----|--|--|---|
| 16 | Charger source priority: To configure charger source priority | Solar and Utility (default)  | Solar energy and utility will charge battery at the same time. |
| | | Only Solar  | Solar energy will be the only charger source no matter utility is available or not. |
| 18 | Alarm control | Alarm on (default)  | Alarm off  |
| | | Return to default display screen (default)  | If selected, no matter how users switch display screen, it will automatically return to default display screen after no button is pressed for 1 minute. |
| 19 | Auto return to default display screen | Stay at latest screen  | If selected, the display screen will stay at latest screen user finally switches. |
| | | Backlight on (default)  | Backlight off  |
| 20 | Backlight control | | |

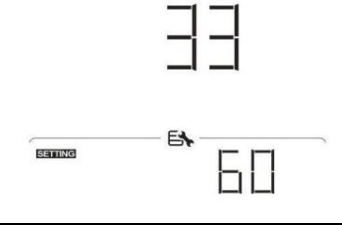
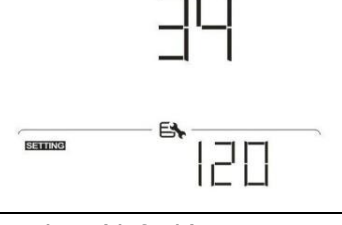
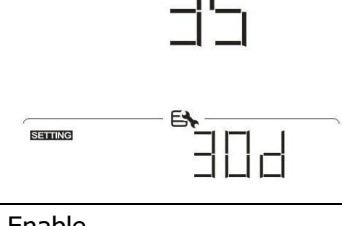
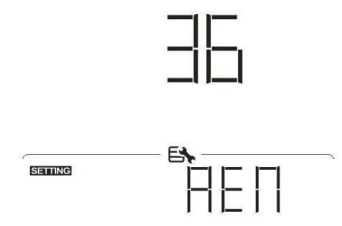
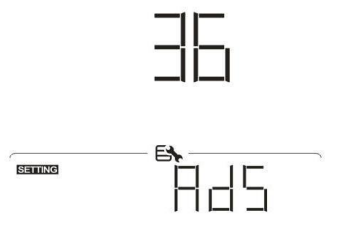
| | | | |
|----|---|---|--|
| 22 | Beeps while primary source is interrupted | Alarm on (default) 22 SETTING AON | Alarm off 22 SETTING AOF |
| 23 | Overload bypass: When enabled, the unit will transfer to line mode if overload occurs in battery mode. | Bypass disable (default) 23 SETTING byd | Bypass enable 23 SETTING byE |
| 25 | Record Fault code | Record enable (default) 25 SETTING FEN | Record disable 25 SETTING FdS |
| 26 | Bulk charging voltage (C.V voltage) | 56.4V (default) 26 SETTING C456.4 | If user-defined is selected in program 5, this program can be set up. Setting range is from 48.0V to 62.0V. Increment of each click is 0.1V. |
| 27 | Floating charging voltage | 54V (default) 27 SETTING FL454.0 | If user-defined is selected in program 5, this program can be set up. Setting range is from 48.0V to 62.0V. Increment of each click is 0.1V. |
| 28 | AC output mode *This setting is only available when the inverter is in standby mode (Switch off). | Single: This inverter is used in single phase application. 28 SETTING SIG | Parallel: This inverter is operated in parallel system. 28 SETTING PAL |

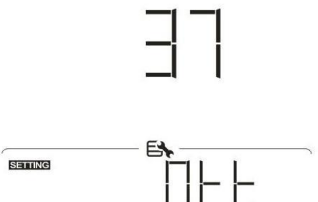
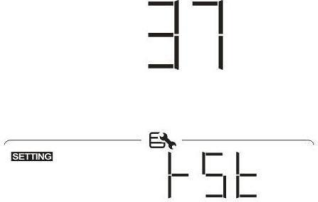
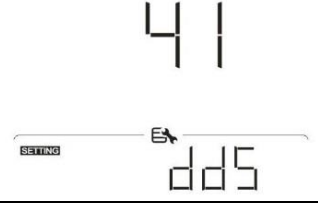
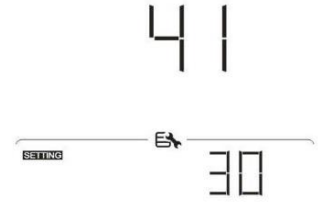
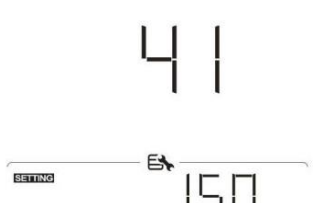
| | | | |
|----|---|--|---|
| 28 | <p>AC output mode *This setting is only available when the inverter is in standby mode (Switch off).</p> | <p>When the inverter is operated in 3-phase application, set up inverter to be operated in specific phase.</p> <p>L1 phase:</p>  <p>L2 phase:</p>  <p>L3 phase:</p>  <p>When the inverter is operation in split phase application, set up inverter to be operated in specific phase. These options are only available for 6.5KW model.</p> <p>L1 for split phase:</p>  <p>L2 for split phase: (180° phase difference)</p>  | <p>L2 for split phase: (120° phase difference)</p>  |
| 29 | <p>Low DC cut-off voltage:</p> <ul style="list-style-type: none"> ● If battery power is only power source available, inverter will shut down. ● If PV energy and battery power are available, inverter will charge battery without AC output. <p>If PV energy, battery power and utility are all available, inverter will transfer to line mode</p> | <p>42.0V (default)</p>  | <p>If user-defined is selected in program 5, this program can be set up. Setting range is from 42.0V to 48.0V. Increment of each click is 0.1V. Low DC cut-off voltage will be fixed to setting value no matter what percentage of load is connected.</p> |

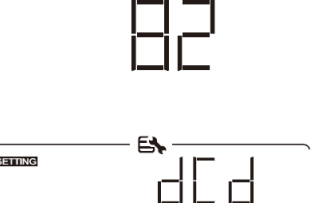
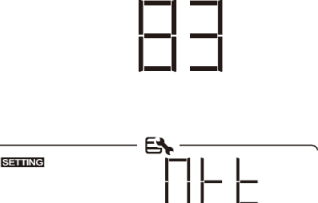
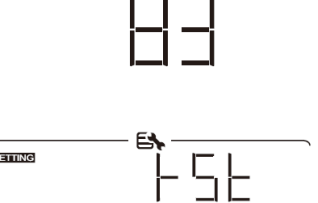
| | | | |
|----|------------------------------------|--|---|
| 30 | Battery equalization | Battery equalization  | Battery equalization disable (default)  |
| | | If "Flooded" or "User-Defined" is selected in program 05, this program can be set up. | |
| 31 | Battery equalization voltage | 58.4V (default)  | Setting range is from 48.0V to 62.0V. Increment of each click is 0.1V. |
| 33 | Battery equalized time | 60min (default)  | Setting range is from 5 min to 900 min. Increment of each click is 5 min. |
| 34 | Battery equalized timeout | 120min (default)  | Setting range is from 5 min to 900 min. Increment of each click is 5 min. |
| 35 | Equalization interval | 30days (default)  | Setting range is from 0 to 90 days. Increment of each click is 1 day |
| 36 | Equalization activated immediately | Enable  | Disable (default)  |

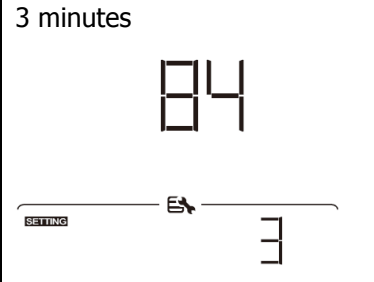
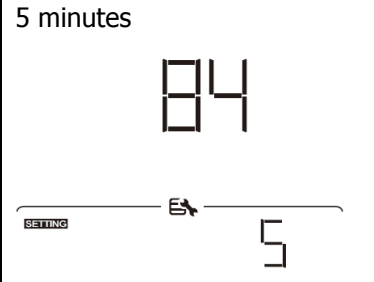
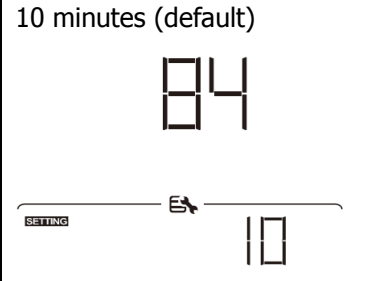
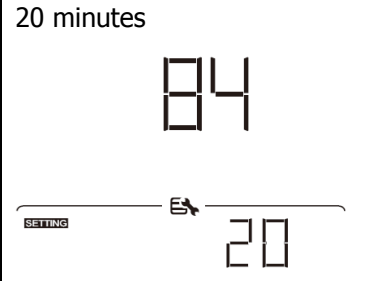
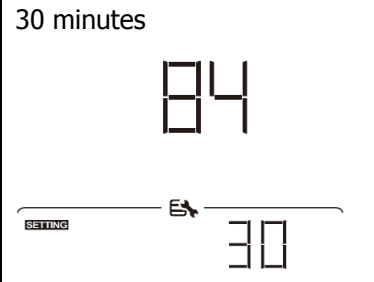
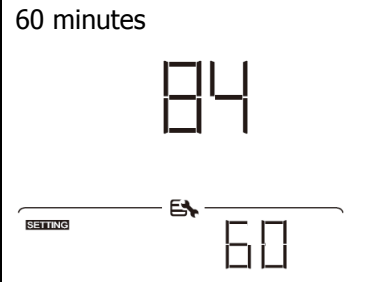
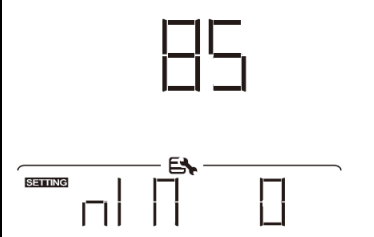
| | | | |
|----|---|--|---|
| | | <p>If equalization function is enabled in program 30, this program can be set up. If "Enable" is selected in this program, it's to activate battery equalization immediately and LCD main page will show "E9". If "Disable" is selected, it will cancel equalization function until next activated equalization time arrives based on program 35 setting. At this time, "E9" will not be shown in LCD main page.</p> | |
| 37 | Reset all stored data for PV generated power and output load energy | Not reset(Default)  | Reset  |
| 41 | Maximum battery discharging current | Disable (Default)  | If selected, battery discharge protection is disabled. |
| | | 30A  | The setting range is from 30 A to 150 A. Increment of each click is 10A. If discharging current is higher than setting value, battery will stop discharging. At this time, if the utility is available, the inverter will operate in bypass mode. If no utility is available, the inverter will shut down output after 5-minute operation in battery mode. |
| | | 150A  | |
| 82 | On/Off control for 12V DC output | Enable (default)  | Disable  |
| 83 | Erase all data log | Not reset (Default)  | Reset  |

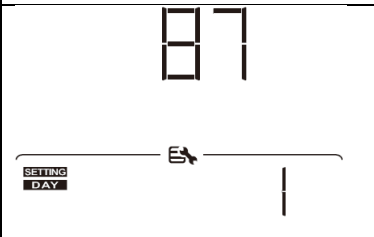
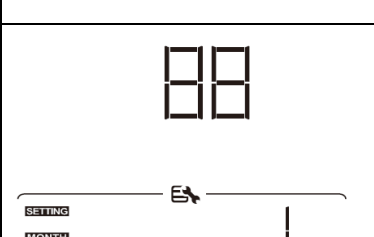

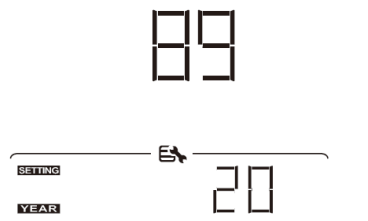
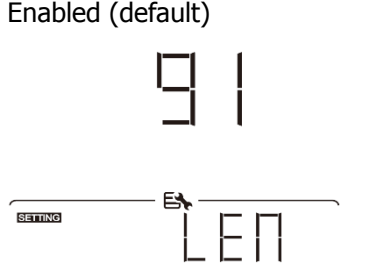
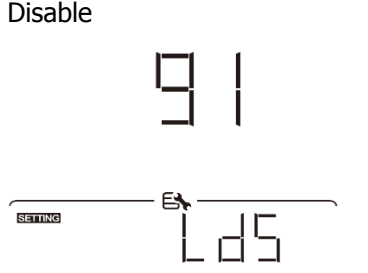
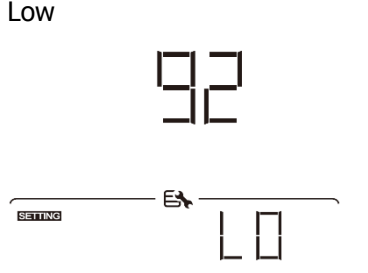
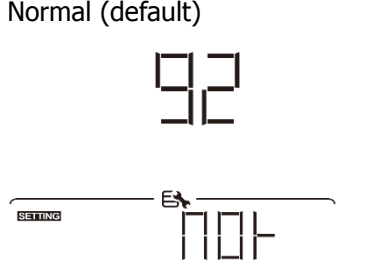
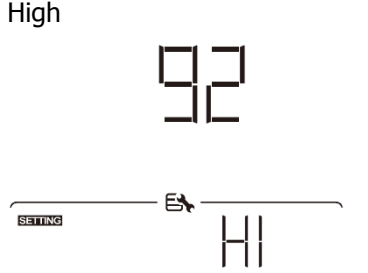
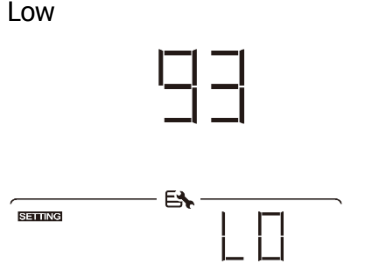
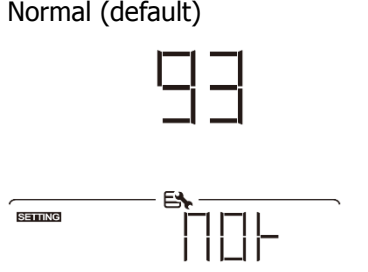
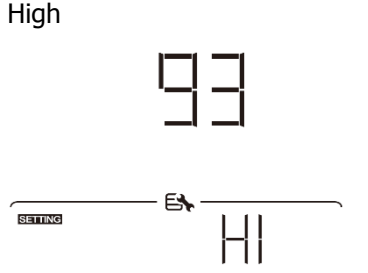
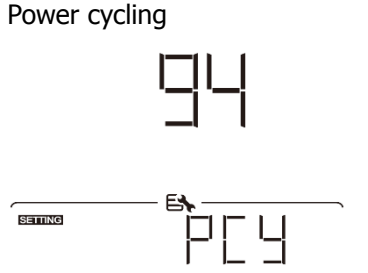
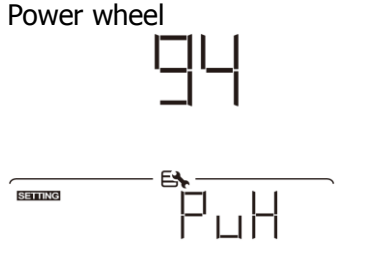
| | | | |
|----|--|--|---|
| 84 | Data log recorded interval *The maximum data log number is 1440. If it's over 1440, it will re-write the first log. | 3 minutes  | 5 minutes  |
| | | 10 minutes (default)  | 20 minutes  |
| | | 30 minutes  | 60 minutes  |
| | | | |
| 85 | Time setting – Minute |  | For minute setting, the range is from 0 to 59. |
| 86 | Time setting – Hour |  | For hour setting, the range is from 0 to 23. |
| 87 | Time setting– Day |  | For day setting, the range is from 1 to 31. |
| 88 | Time setting– Month |  | For month setting, the range is from 1 to 12. |

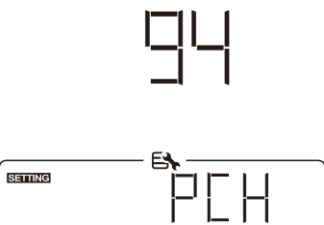
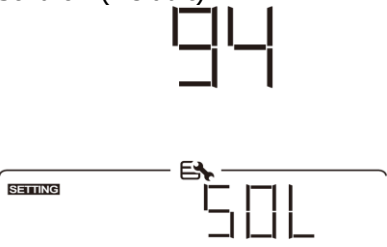
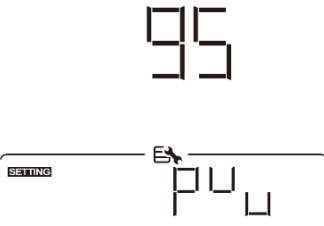
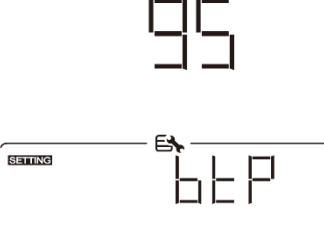
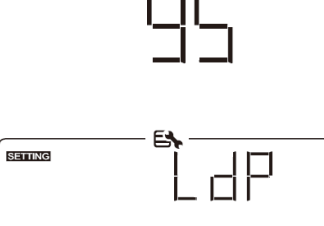
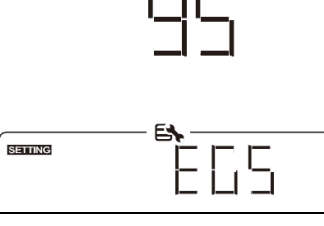
| | | | |
|----|--|---|---|
| 89 | Time setting – Year |  | For year setting, the range is from 17 to 99. |
| 91 | On/Off control for RGB LED *It's required to enable this setting to activate RGB LED lighting function. | Enabled (default)  | Disable  |
| 92 | Brightness of RGB LED | Low  | Normal (default)  |
| | | High  | |
| 93 | Lighting speed of RGB LED | Low  | Normal (default)  |
| | | High  | |
| 94 | RGB LED effects | Power cycling  | Power wheel  |

| | | | |
|----|---|---|--|
| 94 | RGB LED effects | Power chasing  | Solid on (Default)  |
| 95 | Data Presentation of data color *Energy source (Grid-PV-Battery) and battery charge/discharge status only available when RGB LED effects is set to Solid on. | Solar input power in watt  | LED lighting portion will be changed by the percentage of solar input power and nominal PV power. If "Solid on" is selected in #94, LED ring will light up with background color setting in #96. If "Power wheel" is selected in #94, LED ring will light up in 4 levels. If "cycling" or "chasing" is selected in #94, LED ring will light up in 12 levels. |
| | | Battery capacity percentage (Default)  | LED lighting portion will be changed by battery capacity percentage. If "Solid on" is selected in #94, LED ring will light up with background color setting in #96. If "Power wheel" is selected in #94, LED ring will light up in 4 levels. If "cycling" or "chasing" is selected in #94, LED ring will light up in 12 levels. |
| | | Load percentage.  | LED lighting portion will be changed by load percentage. If "Solid on" is selected in #94, LED ring will light up with background color setting in #96. If "Power wheel" is selected in #94, LED ring will light up in 4 levels. If "cycling" or "chasing" is selected in #94, LED ring will light up in 12 levels. |
| | | Energy source(Grid-PV-Battery)  | If selected, the LED color will be background color setting in #96 in AC mode. If PV power is active, the LED color will be data color setting in #97. If the remaining status occur, the LED color will be set in #98. |

| | | | |
|----|---|--|---|
| 95 | Data Presentation of data color *Energy source (Grid-PV-Battery) and battery charge/discharge status only available when RGB LED effects is set to Solid on. | Battery charge/discharge status 95 SETTING ← E → bts | If selected, the LED color will be background color setting in #96 in battery charging status. The LED color will be data color setting in #98 in battery discharging status. |
| 96 | Background color of RGB LED | Pink 96 SETTING ← E → PIN | Orange 96 SETTING ← E → ORA |
| | | Yellow 96 SETTING ← E → YEL | Green 96 SETTING ← E → GFE |
| | | Blue 96 SETTING ← E → BLU | Sky blue (Default) 96 SETTING ← E → SBL |
| | | Purple 96 SETTING ← E → PUT | Other: If selected, the background color is set by RGB via software. 96 SETTING ← E → OTH |
| 97 | Data Color for RGB LED | Pink 97 SETTING ← E → PIN | Orange 97 SETTING ← E → ORA |

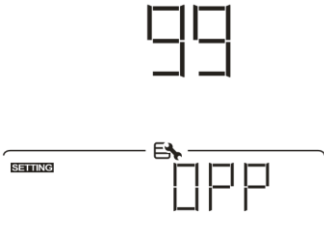
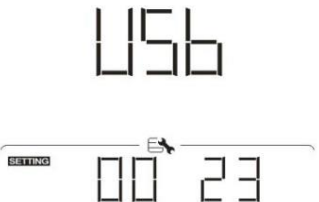
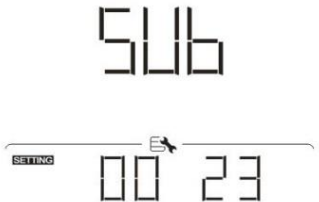
| | | | |
|------------------|--|--------|----------|
| 97 | Data Color for RGB LED | Yellow | Green |
| | | | |
| | | | |
| | | Blue | Sky blue |
| | | | |
| | | | |
| Purple (Default) | Other: If selected, the data color is set by RGB via software. | | |
| | | | |
| | | | |
| 98 | Background color of RGB LED *Only available when data Presentation of data color is set to Energy source (Grid-PV-Battery). | Pink | Orange |
| | | | |
| | | | |
| | | Yellow | Green |
| | | | |
| | | | |
| Blue | Sky blue (Default) | | |
| | | | |
| | | | |
| Purple | Other: If selected, the background color is set by RGB via software. | | |
| | | | |
| | | | |

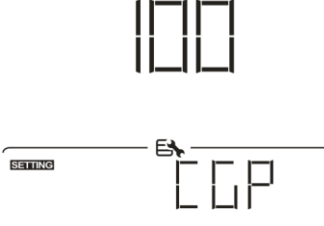
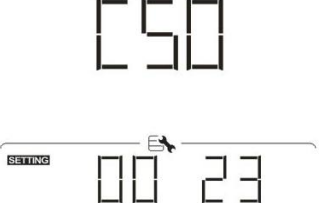
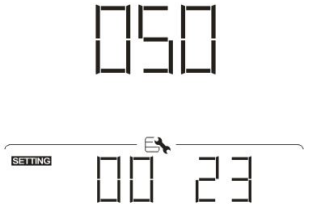
| | | | |
|-----|--|--|--|
| 99 | <p>Timer Setting for Output Source Priority</p>  | <p>Once access this program, it will show "OPP" in LCD. Press "←" button to select timer setting for output source priority. There are three timers to set up. Press "▲" or "▼" button to select specific timer option. Then, press "←" to confirm timer option. Press "▲" or "▼" button to adjust starting time first and the setting range is from 00 to 23. Increment of each click is one hour. Press "←" to confirm starting time setting. Next, the cursor will jump to right column to set up end time. Once end time is set completely, press "←" to confirm all setting.</p> | |
| | | <p>Utility first timer</p>  | <p>Solar first timer</p>  |
| | | <p>SBU priority timer</p>  | |
| 100 | <p>Timer Setting for Charger Source Priority</p>  | <p>Once access this program, it will show "CGP" in LCD. Press "←" button to select timer setting for charger source priority. There are three timers to set up. Press "▲" or "▼" button to select specific timer option. Then, press "←" to confirm timer option. Press "▲" or "▼" button to adjust starting time first and the setting range is from 00 to 23. Increment of each click is one hour. Press "←" to confirm starting time setting. Next, the cursor will jump to right column to set up end time. Once end time is set completely, press "←" to confirm all setting.</p> | |
| | | <p>Solar first</p>  | <p>Solar and utility</p>  |
| | | <p>Only solar</p>  | |

USB Function Setting

There are three USB function setting such as firmware upgrade, data log export and internal parameter re-write from the USB disk. Please follow below procedure to execute selected USB function setting.

| Procedure | LCD Screen |
|--|------------|
| Step 1: Insert an OTG USB disk into the USB port (L). | UPG |
| Step 2: Press "↻" button to enter USB function setting. | SETTING |

Step 3: Please select setting program by following the procedure.

| Program# | Operation Procedure | LCD Screen |
|------------------------------|---|----------------------|
| Upgrade firmware | After entering USB function setting, press "←" button to enter "upgrade firmware" function. This function is to upgrade inverter firmware. If firmware upgrade is needed, please check with your dealer or installer for detail instructions. | UPG |
| Re-write internal parameters | After entering USB function setting, press "▼" button to switch to "Re-write internal parameters" function. This function is to overwrite all parameter settings (TEXT file) with settings in the USB disk from a previous setup or to duplicate inverter settings. Please check with your dealer or installer for detail instructions. | SET |
| Export data log | After entering USB function setting, press "▼" button twice to switch to "export data log" function and it will show "LOG" in the LCD. Press "←" button to confirm the selection for export data log. | LOG |
| | If the selected function is ready, LCD will display "fdy". Press "←" button to confirm the selection again. <ul style="list-style-type: none"> ● Press "▲" button to select "Yes" to export data log. "YES" will disappear after this action is complete. Then, press "↻" button to return to main screen. ● Or press "▼" button to select "No" to return to main screen. | LOG fdy YES NO |

If no button is pressed for 1 minute, it will automatically return to main screen.

Error message:

| Error Code | Messages |
|------------|---|
| U01 | No USB disk is detected. |
| U02 | USB disk is protected from copy. |
| U03 | Document inside the USB disk with wrong format. |

If any error occurs, error code will only show 3 seconds. After 3 seconds, it will automatically return to display screen.

LCD Display

The LCD display information will be switched in turn by pressing the "▲" or "▼" button. The selectable information is switched as the following table in order.

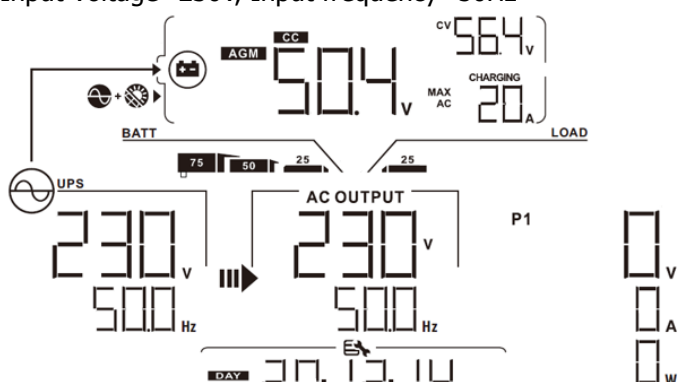
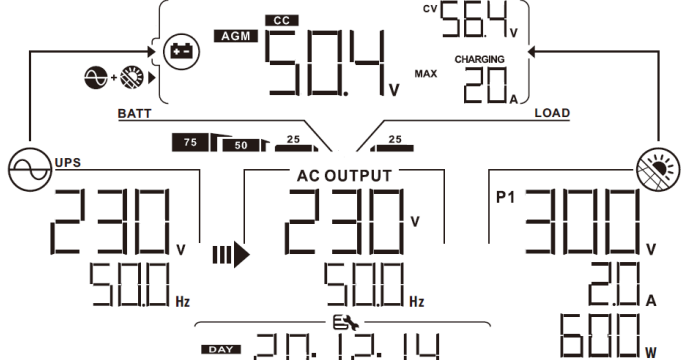
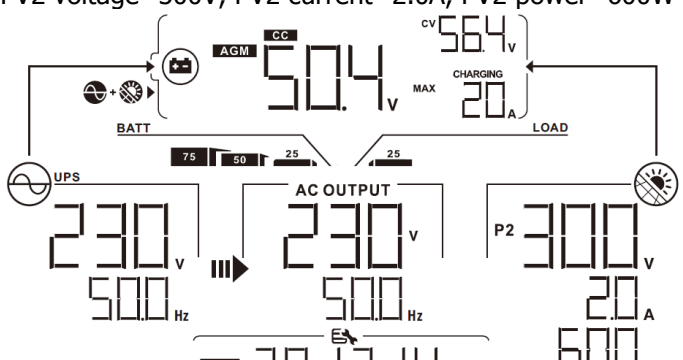
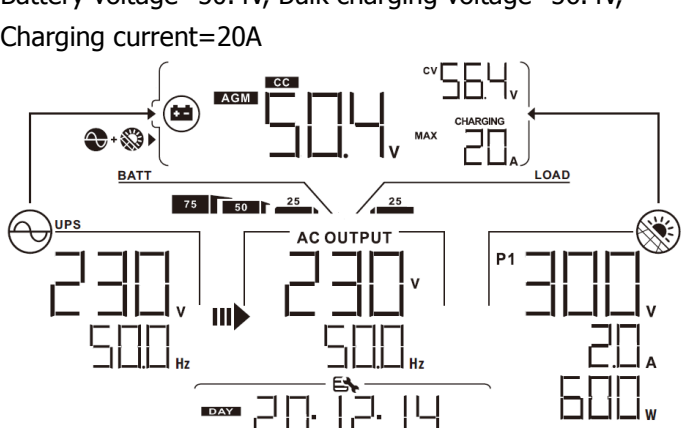
| Selectable information | LCD display |
|---|--|
| Utility voltage/ Utility frequency | <p>Input Voltage=230V, Input frequency=50Hz</p>  |
| Default Display Screen PV voltage/ PV current/ PV power (PV1 and PV2 switch every 5 seconds) | <p>PV1 voltage=300V, PV1 current=2.0A, PV1 power=600W</p>  |
| | <p>PV2 voltage=300V, PV2 current=2.0A, PV2 power=600W</p>  |
| Battery voltage, charging stage/ Configured battery parameters/ Charging or discharging current | <p>Battery voltage=50.4V, Bulk charging voltage=56.4V, Charging current=20A</p>  |

Default Display Screen

Battery voltage, charging stage/
Configured battery parameters/
Charging or discharging current

Battery voltage=53.9V, Floating charging voltage=54.0V,
Charging current=1A

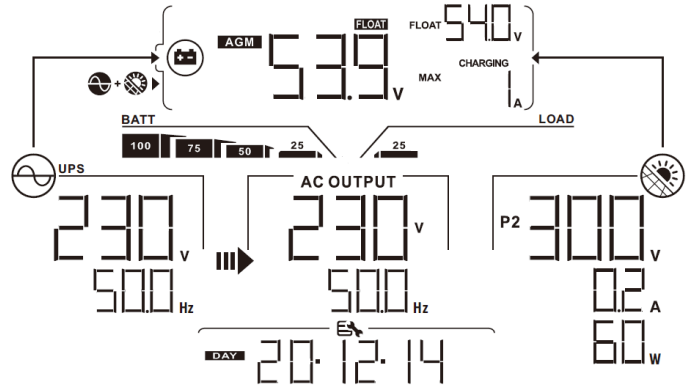

Battery voltage=50.4V, Low DC cut-off voltage=44.0V,
Discharging current=48A

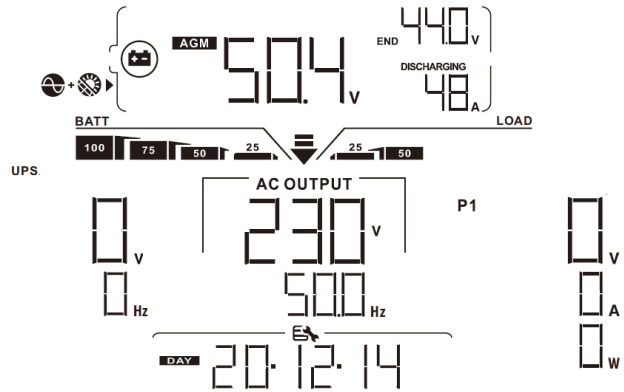

Output voltage, load in VA, load in
Watt switch every 5 second/
Output frequency

Output voltage=230V, Output frequency=50Hz

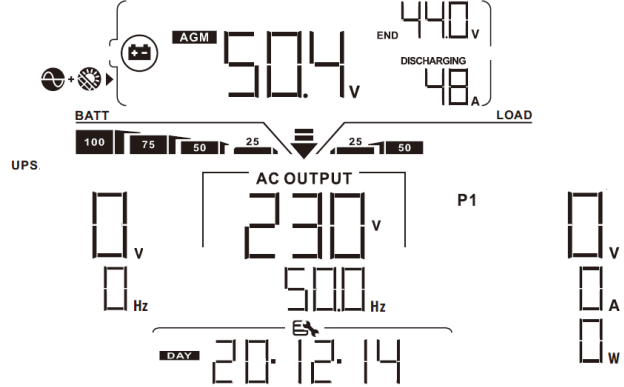

Load in VA=2.4kVA, Output frequency=50Hz

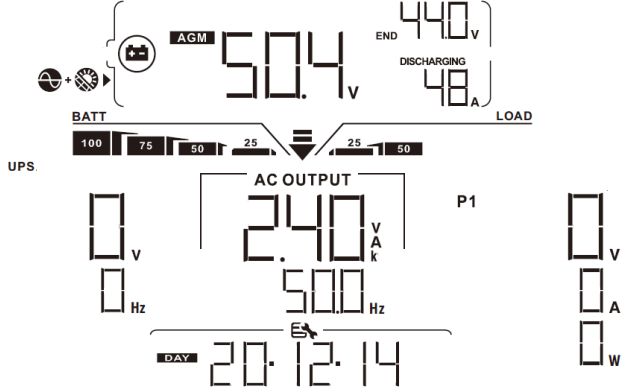

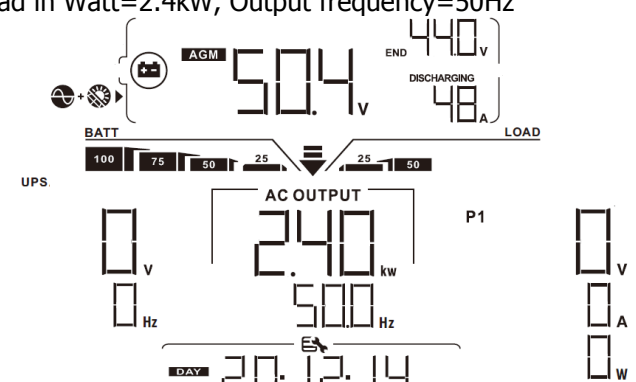
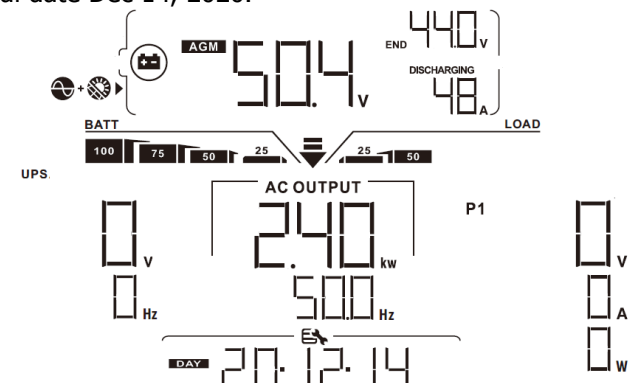
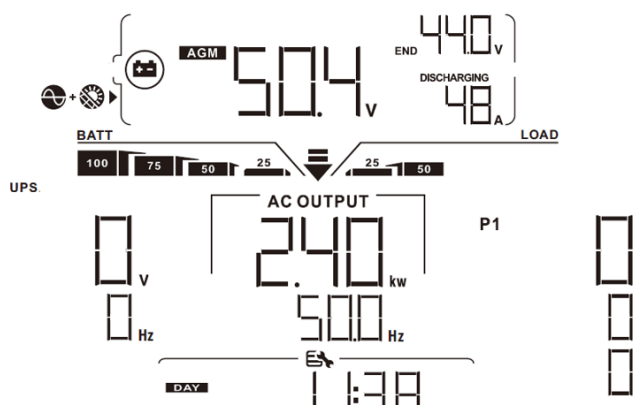
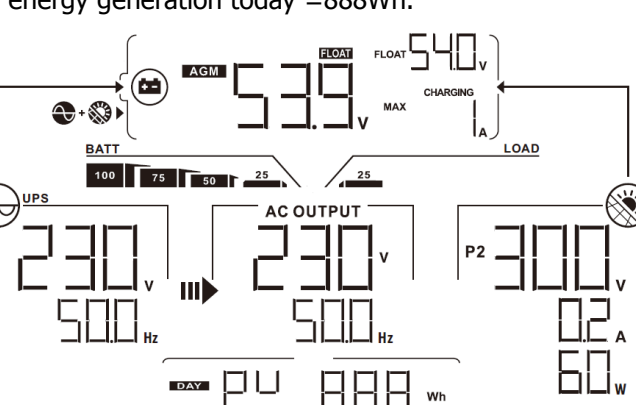
| | | |
|-----------------------------------|---|---|
| <p>Default Display Screen</p> | <p>Output voltage, load in VA, load in Watt switch every 5 second/ Output frequency</p> | <p>Load in Watt=2.4kW, Output frequency=50Hz</p>  |
| <p>Real date</p> | <p>Real date.</p> | <p>Real date Dec 14, 2020.</p>  |
| <p>Real time.</p> | <p>Real time.</p> | <p>Real time 11:38.</p>  |
| <p>PV energy generation today</p> | <p>PV energy generation today</p> | <p>PV energy generation today =888Wh.</p>  |

PV energy generation this month

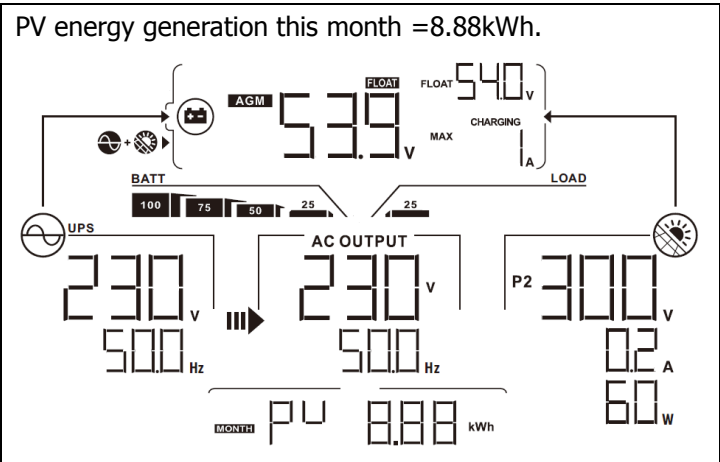

PV energy generation this year

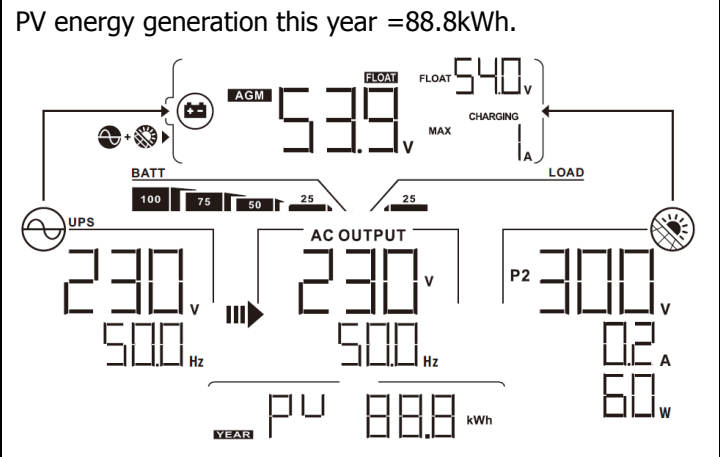

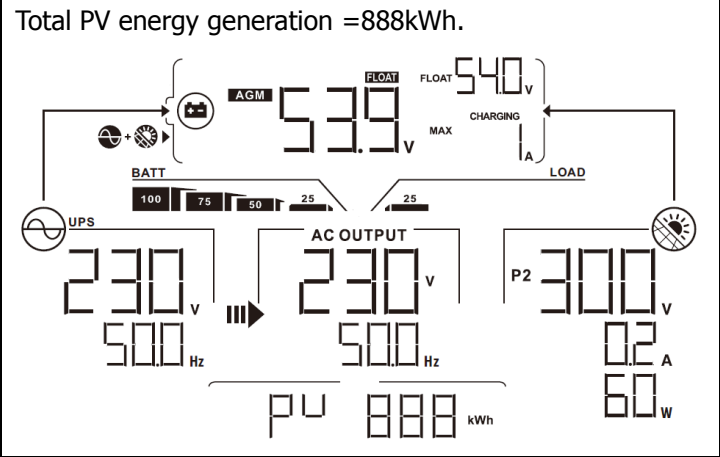

Total PV energy generation



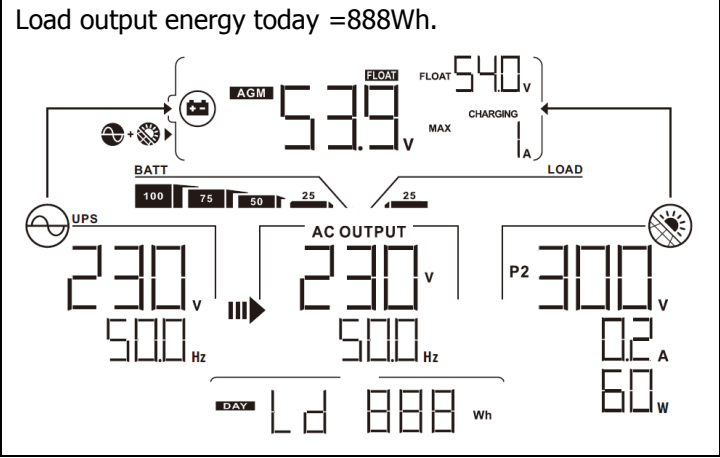

Load output energy today



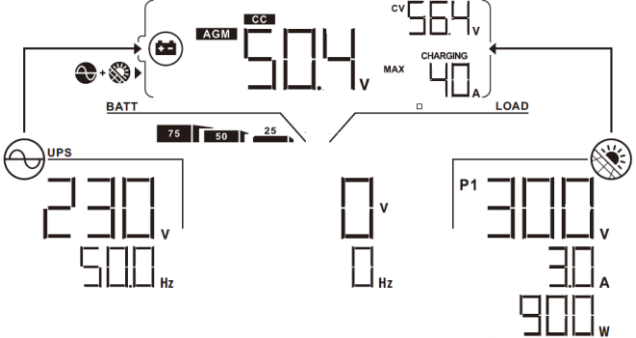
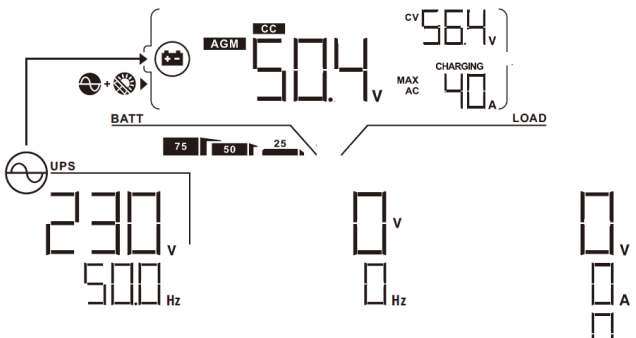
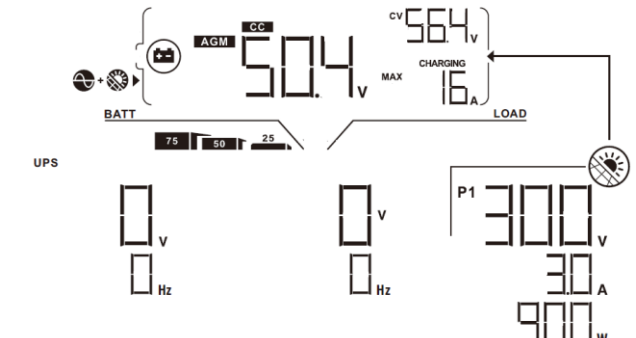

| | |
|--------------------------------------|--|
| <p>Load output energy this month</p> | <p>Load output energy this month =8.88kWh.</p> |
| <p>Load output energy this year</p> | <p>Load output energy this year =88.8kWh.</p> |
| <p>Total load output energy</p> | <p>Total load output energy =888kWh.</p> |
| <p>Main CPU version checking.</p> | <p>Main CPU version 00050.72.</p> |

| | |
|--|--|
| <p>Secondary CPU version checking.</p> | <p>Secondary CPU version 00022.01.</p>  <p>The display shows the following information: <ul style="list-style-type: none"> AGM battery level: 50.4 V END 44.0 V DISCHARGING 20 A BATT level bar: 100, 75, 50, 25 UPS level bar: 25, 25 AC OUTPUT: 230 V, 600 Hz P1 Version number: U22201 Output meters: V, A, W </p> |
| <p>Wi-Fi version checking</p> | <p>Wi-Fi version 00088.88.</p>  <p>The display shows the following information: <ul style="list-style-type: none"> AGM battery level: 50.4 V END 44.0 V DISCHARGING 20 A BATT level bar: 100, 75, 50, 25 UPS level bar: 25, 25 AC OUTPUT: 230 V, 600 Hz P1 Version number: U388888 Output meters: V, A, W </p> |

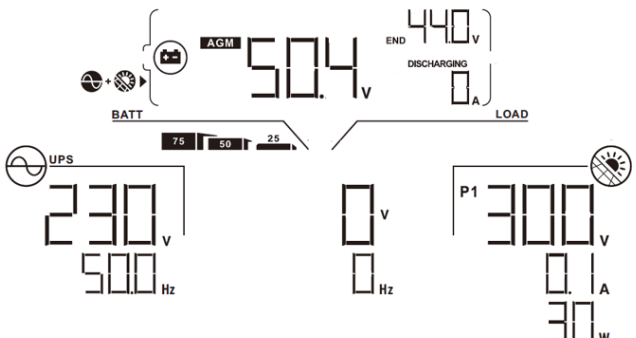
Operating Mode Description

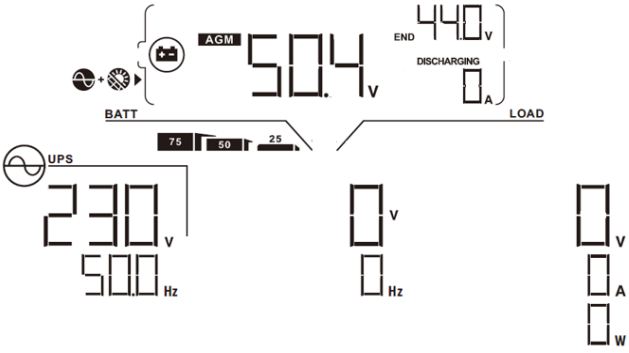
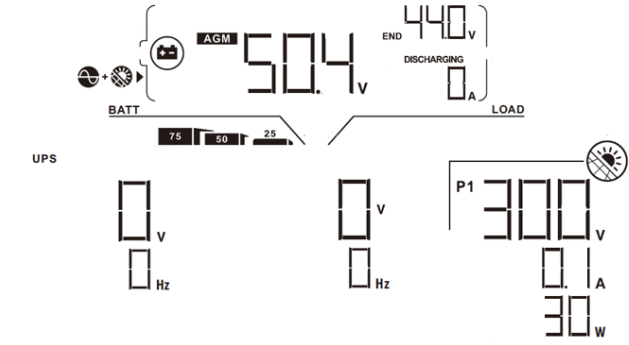
| Operation mode | Description | LCD display |
|--|---|--|
| <p>Standby mode</p> <p>Note:</p> <p>*Standby mode: The inverter is not turned on yet but at this time, the inverter can charge battery without AC output.</p> | <p>No output is supplied by the unit but it still can charge batteries.</p> | <p>Charging by utility and PV energy.</p>  |
| | | <p>Charging by utility.</p>  |
| | | <p>Charging by PV energy.</p>  |
| | | <p>No charging.</p>  |
| <p>Fault mode</p> <p>Note:</p> <p>*Fault mode: Errors are caused by inside circuit error or external reasons such as over temperature, output short circuited and so on.</p> | <p>No charging at all no matter if grid or PV power is available.</p> | <p>Grid and PV power are available.</p>  |

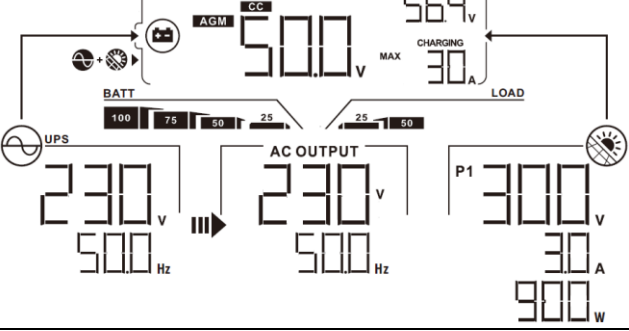
| Operation mode | Description | LCD display |
|--|---|--|
| <p>Fault mode</p> <p>Note:</p> <p>*Fault mode: Errors are caused by inside circuit error or external reasons such as over temperature, output short circuited and so on.</p> | <p>No charging at all no matter if grid or PV power is available.</p> | <p>Grid is available.</p>  |
| | | <p>PV power is available.</p>  |
| | | <p>No charging.</p>  |
| <p>Line Mode</p> | <p>The unit will provide output power from the mains. It will also charge the battery at line mode.</p> | <p>Charging by utility and PV energy.</p>  <p>Charging by utility.</p> |



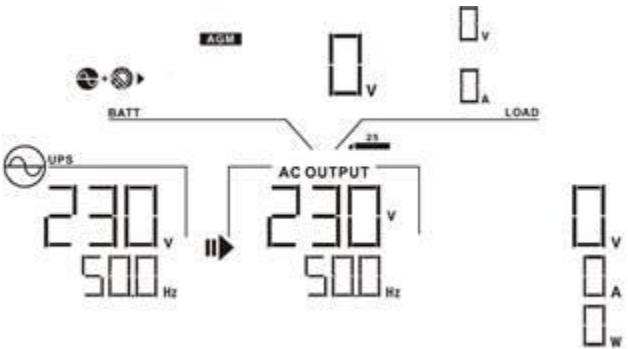
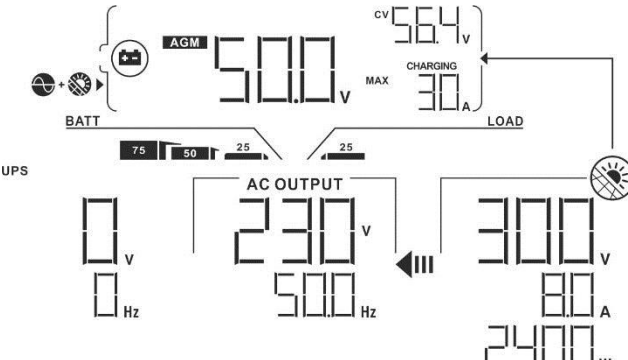
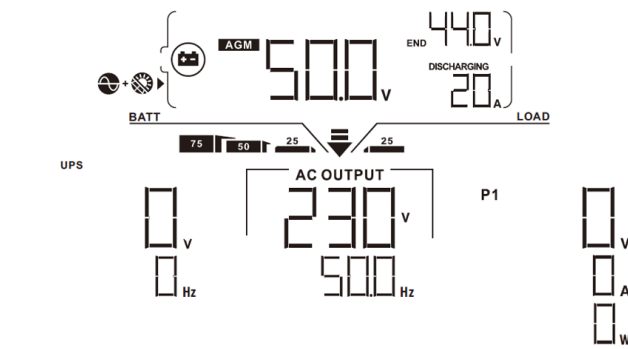
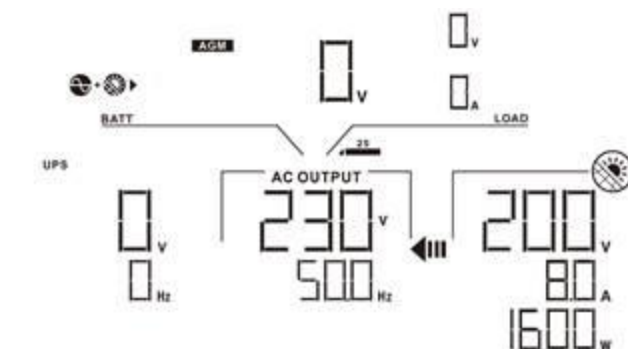







| Operation mode | Description | LCD display |
|----------------|--|---|
| Line Mode | The unit will provide output power from the mains. It will also charge the battery at line mode. | <p>The LCD display shows the following information: <ul style="list-style-type: none"> Top left: Battery status icon (battery with plus sign) and 'AGM' label. Top center: '500 V' (battery voltage). Top right: 'CV 564 V' (charging voltage), 'MAX CHARGING AC 30 A' (charging current limit), and 'LOAD'. Below battery status: 'BATT' label and a battery level bar with segments for 100, 75, 50, and 25. Bottom left: 'UPS' icon and '230 V' / '500 Hz' (input power). Bottom center: 'AC OUTPUT' label and '230 V' / '500 Hz' (output power). Bottom right: 'P1' label and three empty boxes for 'V', 'A', and 'W' (load parameters). </p> |
| | | <p>If "SUB" (solar first) is selected as output source priority and solar energy is not sufficient to provide the load, solar energy and the utility will provide the loads and charge the battery at the same time.</p> <p>The LCD display shows the following information: <ul style="list-style-type: none"> Top left: 'AGM' label and a battery status icon. Top center: '500 V' (battery voltage). Top right: 'V' and 'A' (load parameters). Below battery status: 'BATT' label and a battery level bar with a segment for 25. Bottom left: 'UPS' icon and '230 V' / '500 Hz' (input power). Bottom center: 'AC OUTPUT' label and '230 V' / '500 Hz' (output power). Bottom right: '200 V' / '80 A' / '1600 W' (load parameters) and a solar panel icon. </p> |
| | | <p>If either "SUB" (solar first) or "SBU" is selected as output source priority and battery is not connected, solar energy and the utility will provide the loads.</p> <p>The LCD display shows the following information: <ul style="list-style-type: none"> Top left: 'AGM' label and a battery status icon. Top center: '500 V' (battery voltage). Top right: 'V' and 'A' (load parameters). Below battery status: 'BATT' label and a battery level bar with a segment for 25. Bottom left: 'UPS' icon and '230 V' / '500 Hz' (input power). Bottom center: 'AC OUTPUT' label and '230 V' / '500 Hz' (output power). Bottom right: 'V', 'A', and 'W' (load parameters) and a solar panel icon. </p> |
| | | <p>Power from utility</p> <p>The LCD display shows the following information: <ul style="list-style-type: none"> Top left: 'AGM' label and a battery status icon. Top center: '500 V' (battery voltage). Top right: '440 V' (utility voltage), 'END DISCHARGING' (battery status), and '20 A' (load). Below battery status: 'BATT' label and a battery level bar with segments for 75, 50, and 25. Bottom left: 'UPS' icon and 'V' / 'Hz' (input power). Bottom center: 'AC OUTPUT' label and '230 V' / '500 Hz' (output power). Bottom right: '300 V' / '0.2 A' / '60 W' (load parameters) and a solar panel icon. </p> |

| Operation mode | Description | LCD display |
|----------------|---|--|
| Battery Mode | | <p>Power from battery and PV energy.</p>  |
| | <p>The unit will provide output power from battery and/or PV power.</p> | <p>PV energy will supply power to the loads and charge battery at the same time. No utility is available.</p>  |
| | | <p>Power from battery only.</p>  |
| | | <p>Power from PV energy only.</p>  |

Faults Reference Code

| Fault Code | Fault Event | Icon on |
|------------|-------------------------------------|---------|
| 01 | Fan is locked when inverter is off. | F01 |
| 02 | Over temperature | F02 |
| 03 | Battery voltage is too high | F03 |
| 04 | Battery voltage is too low | F04 |
| 05 | Output short circuited. | F05 |
| 06 | Output voltage is too high. | F06 |
| 07 | Overload time out | F07 |
| 08 | Bus voltage is too high | F08 |
| 09 | Bus soft start failed | F09 |
| 10 | PV over current | F10 |
| 11 | PV over voltage | F11 |
| 12 | DCDC over current | F12 |
| 13 | Battery discharge over current | F13 |
| 51 | Over current | F51 |
| 52 | Bus voltage is too low | F52 |
| 53 | Inverter soft start failed | F53 |
| 55 | Over DC voltage in AC output | F55 |
| 57 | Current sensor failed | F57 |
| 58 | Output voltage is too low | F58 |

Warning Indicator

| Warning Code | Warning Event | Audible Alarm | Icon flashing |
|--------------|--|-------------------------------|---|
| 01 | Fan is locked when inverter is on. | Beep three times every second | 01  |
| 02 | Over temperature | None | 02  |
| 03 | Battery is over-charged | Beep once every second | 03  |
| 04 | Low battery | Beep once every second | 04  |
| 07 | Overload | Beep once every 0.5 second | 07   |
| 10 | Output power derating | Beep twice every 3 seconds | 10  |
| 15 | PV energy is low. | Beep twice every 3 seconds | 15  |
| 16 | High AC input (>280VAC) during BUS soft start | None | 16  |
| 32 | Communication failure between inverter and display panel | None | 32  |
| E9 | Battery equalization | None | E9  |

CLEARANCE AND MAINTENANCE FOR ANTI-DUST KIT

Overview

Every inverter is already installed with anti-dusk kit from factory. This kit keeps dusk from your inverter and increases product reliability in harsh environment.

Clearance and Maintenance

Step 1: Please remove the screws on the sides of the inverter.

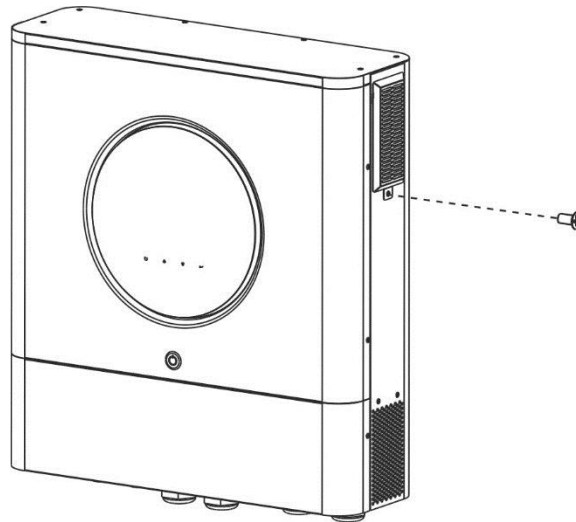

Step 2: Then, dustproof case can be removed and take out air filter foam as shown in below chart.

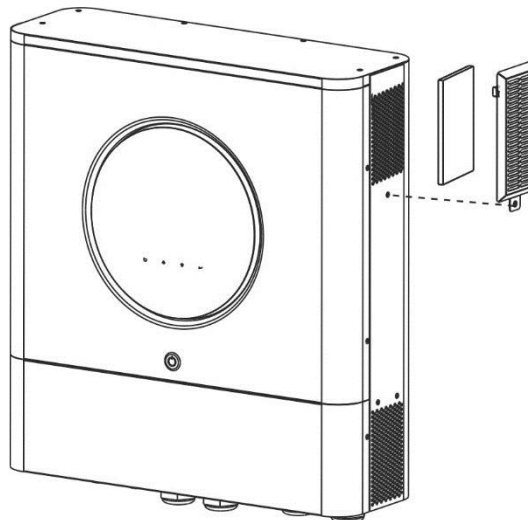

Step 3: Clean air filter foam and dustproof case. After clearance, re-assemble the dust-kit back to the inverter.

NOTICE: The anti-dust kit should be cleaned from dust every one month.

BATTERY EQUALIZATION

Equalization function is added into charge controller. It reverses the buildup of negative chemical effects like stratification, a condition where acid concentration is greater at the bottom of the battery than at the top. Equalization also helps to remove sulfate crystals that might have built up on the plates. If left unchecked, this condition, called sulfation, will reduce the overall capacity of the battery. Therefore, it's recommended to equalize battery periodically.

- **How to Apply Equalization Function**

You must enable battery equalization function in monitoring LCD setting program 33 first. Then, you may apply this function in device by either one of following methods:

1. Setting equalization interval in program 37.
2. Active equalization immediately in program 39.

- **When to Equalize**

In float stage, when the setting equalization interval (battery equalization cycle) is arrived, or equalization is active immediately, the controller will start to enter Equalize stage.

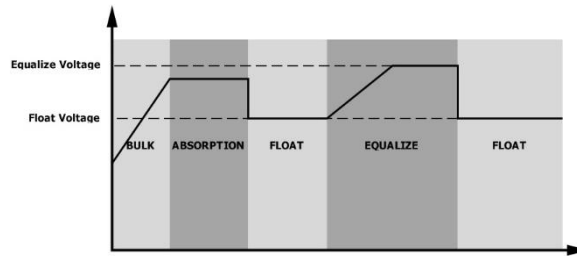

- **Equalize charging time and timeout**

In Equalize stage, the controller will supply power to charge battery as much as possible until battery voltage raises to battery equalization voltage. Then, constant-voltage regulation is applied to maintain battery voltage at the battery equalization voltage. The battery will remain in the Equalize stage until setting battery equalized time is arrived.

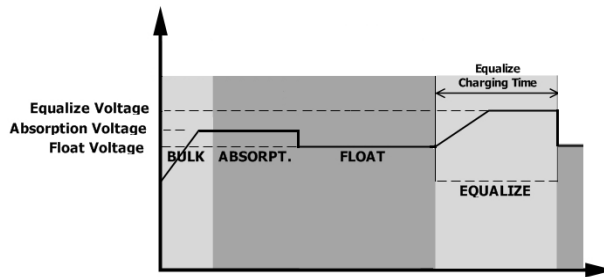

However, in Equalize stage, when battery equalized time is expired and battery voltage doesn't rise to battery equalization voltage point, the charge controller will extend the battery equalized time until battery voltage achieves battery equalization voltage. If battery voltage is still lower than battery equalization voltage when battery equalized timeout setting is over, the charge controller will stop equalization and return to float stage.

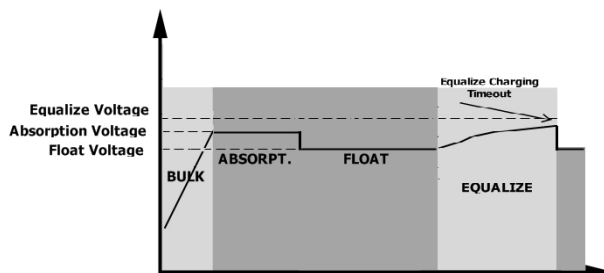

SPECIFICATIONS

Table 1 Line Mode Specifications

| MODEL | 6.5KW | 8KW |
|---|---|--|
| Input Voltage Waveform | Sinusoidal (utility or generator) | |
| Nominal Input Voltage | 120Vac | 230Vac |
| Low Loss Voltage | 90Vac±7V (UPS) 80Vac±7V (Appliances) | 170Vac±7V (UPS) 90Vac±7V (Appliances) |
| Low Loss Return Voltage | 100Vac±7V (UPS); 90Vac±7V (Appliances) | 180Vac±7V (UPS); 100Vac±7V (Appliances) |
| High Loss Voltage | 140Vac±7V | 280Vac±7V |
| High Loss Return Voltage | 135Vac±7V | 270Vac±7V |
| Max AC Input Voltage | 150Vac | 300Vac |
| Max AC Input Current | 60A | |
| Nominal Input Frequency | 50Hz / 60Hz (Auto detection) | |
| Low Loss Frequency | 40±1Hz | |
| Low Loss Return Frequency | 42±1Hz | |
| High Loss Frequency | 65±1Hz | |
| High Loss Return Frequency | 63±1Hz | |
| Output Short Circuit Protection | Line mode: Circuit Breaker Battery mode: Electronic Circuits | |
| Efficiency (Line Mode) | >95% (Rated R load, battery full charged) | |
| Transfer Time | 10ms typical (UPS); 20ms typical (Appliances) | |
| Output power de-rating: When AC input voltage under 170V the output power will be de-rated. | | |

Table 2 Inverter Mode Specifications

| MODEL | 6.5KW | 8KW |
|--|--|------------|
| Rated Output Power | 6500W | 8000W |
| Output Voltage Waveform | Pure Sine Wave | |
| Output Voltage Regulation | 120Vac±5% | 230Vac±5% |
| Output Frequency | 60Hz or 50Hz | |
| Peak Efficiency | 91% | 93% |
| Overload Protection | 100ms@≥205% load;5s@≥150% load; 10s@110%~150% load | |
| Surge Capacity | 2* rated power for 5 seconds | |
| Low DC Warning Voltage @ load < 20% @ 20% ≤ load < 50% @ load < 50% @ load ≥ 50% | 46.0Vdc 42.8Vdc 40.4Vdc | |
| Low DC Warning Return Voltage @ load < 20% @ 20% ≤ load < 50% @ load < 50% @ load ≥ 50% | 48.0Vdc 44.8Vdc 42.4Vdc | |
| Low DC Cut-off Voltage @ load < 20% @ 20% ≤ load < 50% @ load < 50% @ load ≥ 50% | 44.0Vdc 40.8Vdc 38.4Vdc | |
| High DC Recovery Voltage | 64Vdc | |
| High DC Cut-off Voltage | 66Vdc | |
| DC Voltage Accuracy | +/-0.3V@ no load | |
| THDV | <5% for linear load,<10% for non-linear load @ nominal voltage | |
| DC Offset | ≅ 100mV | |
| No Load Power Consumption | <75W | |

Table 3 Charge Mode Specifications

| Utility Charging Mode | | |
|--|---|-------------------------------|
| MODEL | 6.5KW | 8KW |
| Charging Current (UPS) @ Nominal Input Voltage | 120A (@ $V_{I/P}=120V_{ac}$) | 150A (@ $V_{I/P}=230V_{ac}$) |
| Bulk Charging Voltage | Flooded Battery | 58.4Vdc |
| | AGM / Gel Battery | 56.4Vdc |
| Floating Charging Voltage | 54Vdc | |
| Overcharge Protection | 66Vdc | |
| Charging Algorithm | 3-Step | |
| Charging Curve | <p>The graph plots Battery Voltage (per cell) on the left y-axis and Charging Current (%) on the right y-axis against Time on the x-axis. The voltage curve (black) rises linearly in the Bulk phase (T0), plateaus in the Absorption phase (T1), and then slightly drops in the Maintenance phase. The current curve (red) is constant at 100% in the Bulk phase, then decays exponentially in the Absorption phase, and remains at a low level in the Maintenance phase. Key voltage points are marked as 2.43Vdc (2.35Vdc) and 2.25Vdc. Time intervals T0 and T1 are indicated, with a note for T1: 'minimum 10mins, maximum 8hrs'. The x-axis is divided into three shaded regions: Bulk (Constant Current), Absorption (Constant Voltage), and Maintenance (Floating).</p> | |
| Solar Input | | |
| MODEL | 6.5KW | 8KW |
| Rated Power | 8000W | |
| Max. PV Array Open Circuit Voltage | 250Vdc | 500Vdc |
| PV Array MPPT Voltage Range | 90Vdc~230Vdc | 90Vdc~450Vdc |
| Max. Input Current | 18A x 2 | |
| Start-up Voltage | 80V +/- 5Vdc | |
| Power Limitation | <p>The graph plots PV Current on the y-axis against MPPT temperature on the x-axis. A red line shows the current is constant at 18A from 0°C to 75°C. At 75°C, the current drops to 9A and remains constant up to 85°C. Dashed lines indicate the 9A current level and the 75°C and 85°C temperature points.</p> | |

Table 4 General Specifications

| MODEL | 6.5KW | 8KW |
|------------------------------------|--|---------------|
| Safety Compliance | UL | CE |
| Operating Temperature Range | -10°C to 40°C | -10°C to 50°C |
| Storage temperature | -15°C~ 60°C | |
| Humidity | 5% to 95% Relative Humidity (Non-condensing) | |
| Dimension (D*W*H), mm | 158.4x 503.6 x 530.8 | |
| Net Weight, kg | 20 | |

Table 5 Parallel Specifications

| | |
|--|-----------------|
| Max parallel numbers | 6 |
| Circulation Current under No Load Condition | Max 2A |
| Power Unbalance Ratio | <5% @ 100% Load |
| Parallel communication | CAN |
| Transfer time in parallel mode | Max 50ms |
| Parallel Kit | YES |

Note: Parallel feature will be disabled when only PV power is available.

TROUBLE SHOOTING

| Problem | LCD/LED/Buzzer | Explanation / Possible cause | What to do |
|---|---|---|--|
| Unit shuts down automatically during startup process. | LCD/LEDs and buzzer will be active for 3 seconds and then complete off. | The battery voltage is too low (<1.91V/Cell) | 1. Re-charge battery. 2. Replace battery. |
| No response after power on. | No indication. | 1. The battery voltage is far too low. (<1.4V/Cell) 2. Battery polarity is connected reversed. | 1. Check if batteries and the wiring are connected well. 2. Re-charge battery. 3. Replace battery. |
| Mains exist but the unit works in battery mode. | Input voltage is displayed as 0 on the LCD and green LED is flashing. | Input protector is tripped | Check if AC breaker is tripped and AC wiring is connected well. |
| | Green LED is flashing. | Insufficient quality of AC power. (Shore or Generator) | 1. Check if AC wires are too thin and/or too long. 2. Check if generator (if applied) is working well or if input voltage range setting is correct. (UPS→Appliance) |
| | Green LED is flashing. | Set "Solar First" as the priority of output source. | Change output source priority to Utility first. |
| When the unit is turned on, internal relay is switched on and off repeatedly. | LCD display and LEDs are flashing | Battery is disconnected. | Check if battery wires are connected well. |
| Buzzer beeps continuously and red LED is on. | Fault code 07 | Overload error. The inverter is overload 110% and time is up. | Reduce the connected load by switching off some equipment. |
| | Fault code 05 | Output short circuited. | Check if wiring is connected well and remove abnormal load. |
| | Fault code 02 | Internal temperature of inverter component is over 100°C. | Check whether the air flow of the unit is blocked or whether the ambient temperature is too high. |
| | Fault code 03 | Battery is over-charged. | Return to repair center. |
| | | The battery voltage is too high. | Check if spec and quantity of batteries are meet requirements. |
| | Fault code 01 | Fan fault | Replace the fan. |
| | Fault code 06/58 | Output abnormal (Inverter voltage below than 190Vac or is higher than 260Vac) | 1. Reduce the connected load. 2. Return to repair center |
| | Fault code 08/09/53/57 | Internal components failed. | Return to repair center. |
| | Fault code 51 | Over current or surge. | Restart the unit, if the error happens again, please return to repair center. |
| | Fault code 52 | Bus voltage is too low. | |
| Fault code 55 | Output voltage is unbalanced. | | |
| Fault code 56 | Battery is not connected well or fuse is burnt. | If the battery is connected well, please return to repair center. | |

Appendix I: Parallel function

1. Introduction

This inverter can be used in parallel with two different operation modes.

1. Parallel operation in single phase is with up to 6 units. The supported maximum output power for 8KW model is 48KW/48KVA. The supported maximum output power for 6.5KW model is 39KW/39KVA.
2. Maximum six units work together to support three-phase equipment. Maximum four units support one phase.
3. Maximum six units work together to support split-phase equipment only available for 6.5KW model. Maximum 5 units support one phase application. The supported maximum output power is 39KW/39KVA and one phase can be up to 32.5KW/32.5KVA.

2. Mounting the Unit

When installing multiple units, please follow below chart.

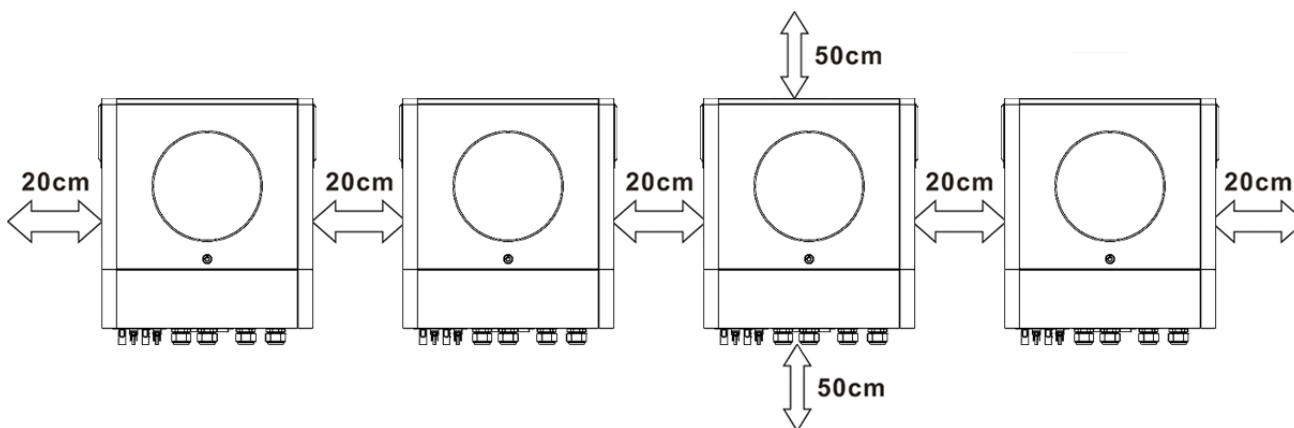

NOTE: For proper air circulation to dissipate heat, allow a clearance of approx. 20 cm to the side and approx. 50 cm above and below the unit. Be sure to install each unit in the same level.

3. Wiring Connection

WARNING: It's REQUIRED to connect battery for parallel operation.

The cable size of each inverter is shown as below:

Recommended battery cable and terminal size for each inverter:

| Wire Size | Cable mm ² | Ring Terminal Dimensions | | Torque value |
|-----------|-----------------------|--------------------------|--------|--------------|
| | | D (mm) | L (mm) | |
| 1*2/0AWG | 67.4 | 8.4 | 47 | 5 Nm |

Ring terminal:

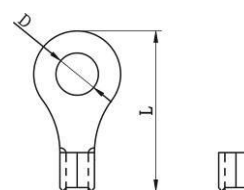

WARNING: Be sure the length of all battery cables is the same. Otherwise, there will be voltage difference between inverter and battery to cause parallel inverters not working.

Recommended AC input and output cable size for each inverter:

| Model | AWG no. | Torque |
|-------|---------|-------------|
| 6.5KW | 4 AWG | 1.4~ 1.6 Nm |
| 8KW | 8 AWG | 1.4~ 1.6 Nm |

You need to connect the cables of each inverter together. Take the battery cables for example: You need to use a connector or bus-bar as a joint to connect the battery cables together, and then connect to the battery terminal. The cable size used from joint to battery should be X times cable size in the tables above. "X" indicates the number of inverters connected in parallel.

Regarding AC input and output, please also follow the same principle.

CAUTION!! Please install the breaker at the battery and AC input side. This will ensure the inverter can be

securely disconnected during maintenance and fully protected from over current of battery or AC input.

Recommended breaker specification of battery for each inverter:

| Model | 1 unit* |
|-----------|------------|
| 6.5KW/8KW | 250A/70VDC |

*If you want to use only one breaker at the battery side for the whole system, the rating of the breaker should be X times current of 1 unit. "X" indicates the number of inverters connected in parallel.

Recommended breaker specification of AC input with single phase:

| Model | 2 units | 3 units | 4 units | 5 units | 6 units |
|-----------|-------------|-------------|-------------|-------------|-------------|
| 6.5KW/8KW | 120A/230VAC | 180A/230VAC | 240A/230VAC | 300A/230VAC | 360A/230VAC |

Note 1: Also, you can use 60A breaker with only 1 unit and install one breaker at its AC input in each inverter.

Note 2: Regarding three-phase system, you can use 4-pole breaker directly and the rating of the breaker should be compatible with the phase current limitation from the phase with maximum units

Recommended battery capacity

| Inverter parallel numbers | 2 | 3 | 4 | 5 | 6 |
|---------------------------|-------|-------|-------|-------|-------|
| Battery Capacity | 200AH | 400AH | 400AH | 600AH | 600AH |

WARNING! Be sure that all inverters will share the same battery bank. Otherwise, the inverters will transfer to fault mode.

4-1. Parallel Operation in Single phase

Two inverters in parallel:

Power Connection

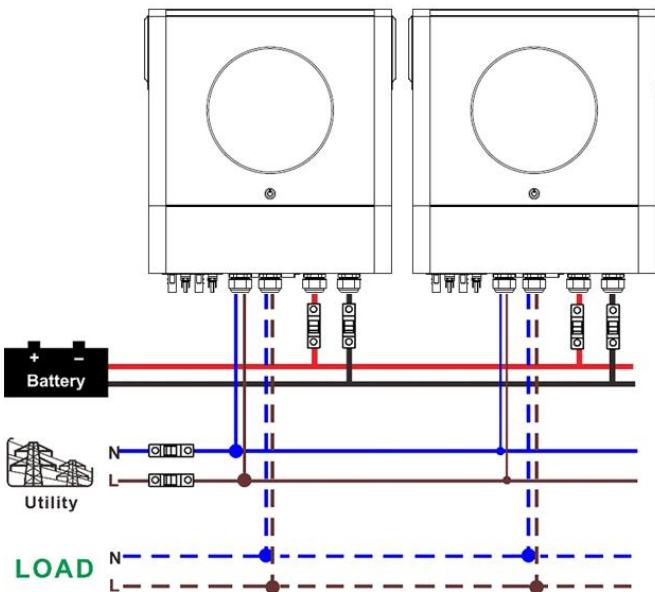

Communication Connection

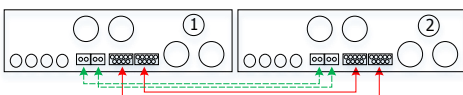

Three inverters in parallel:

Power Connection

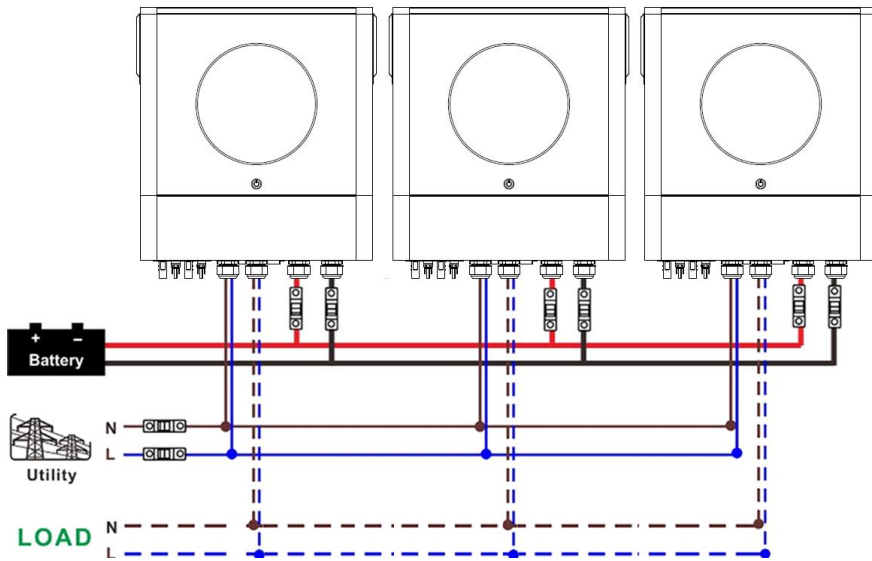

Communication Connection

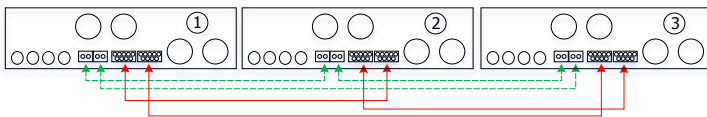

Four inverters in parallel:

Power Connection

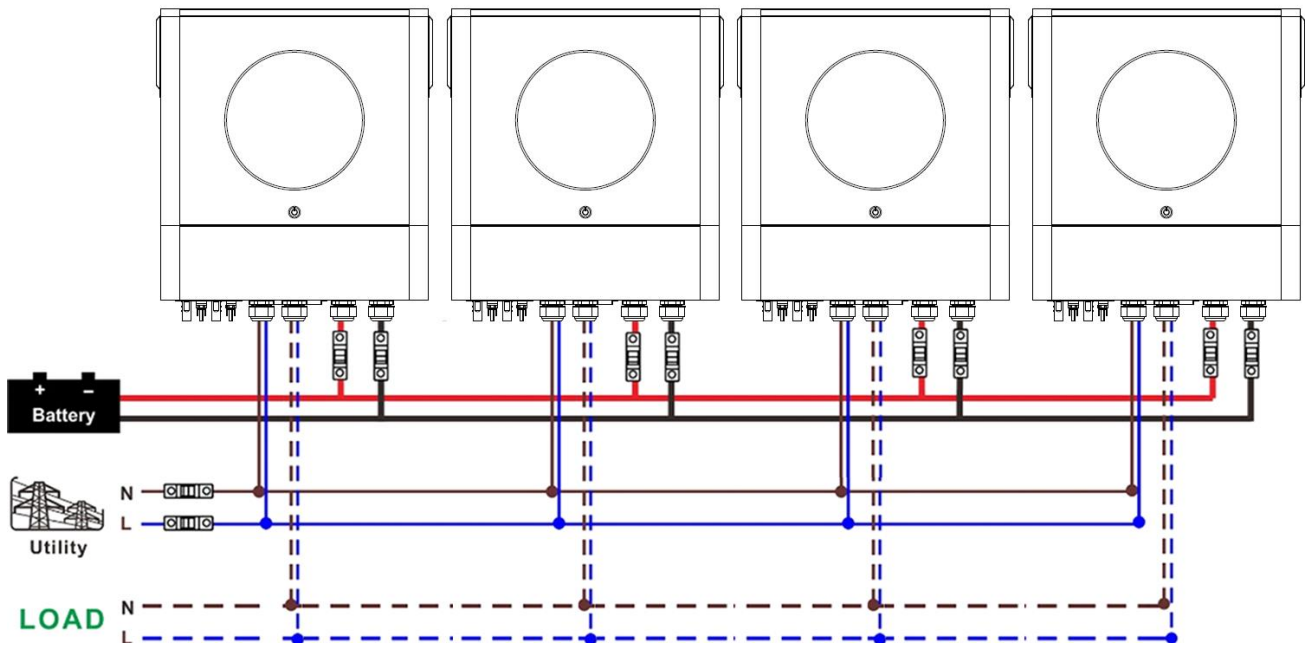

Communication Connection

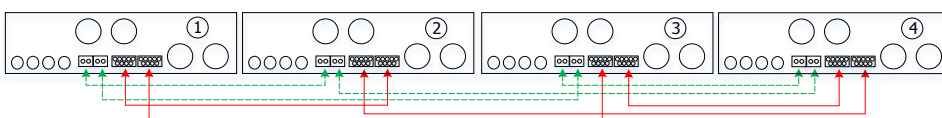

Five inverters in parallel:

Power Connection

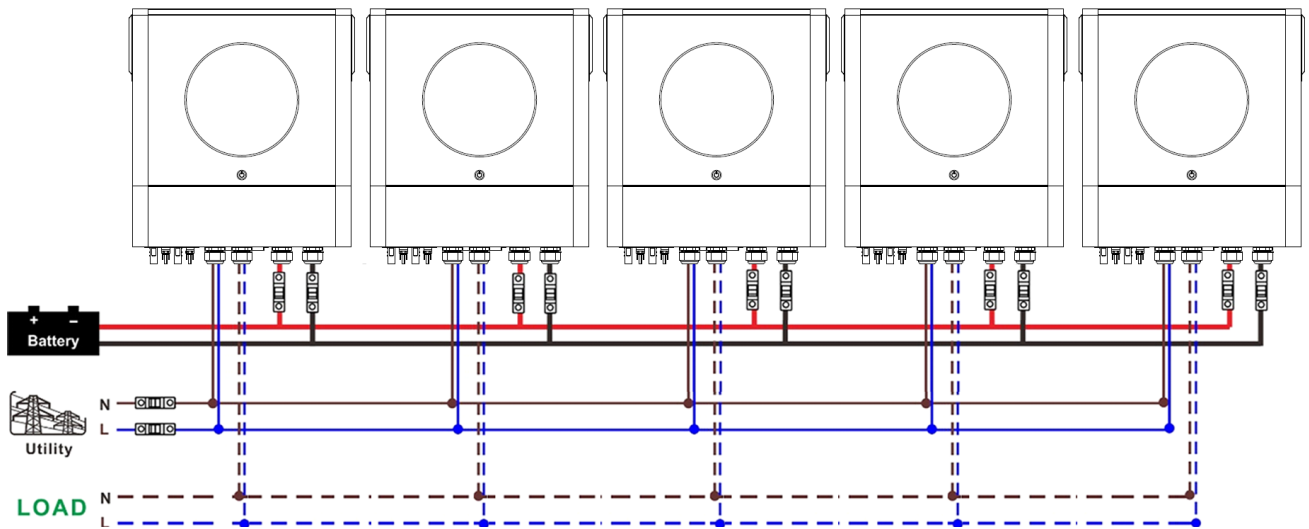

Communication Connection

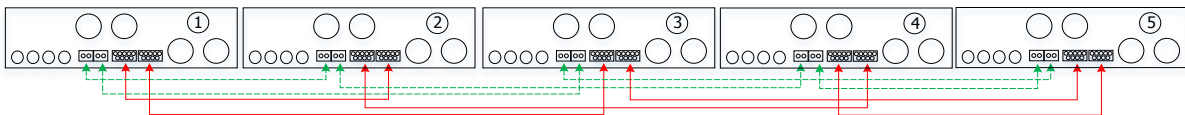

Six inverters in parallel:

Power Connection

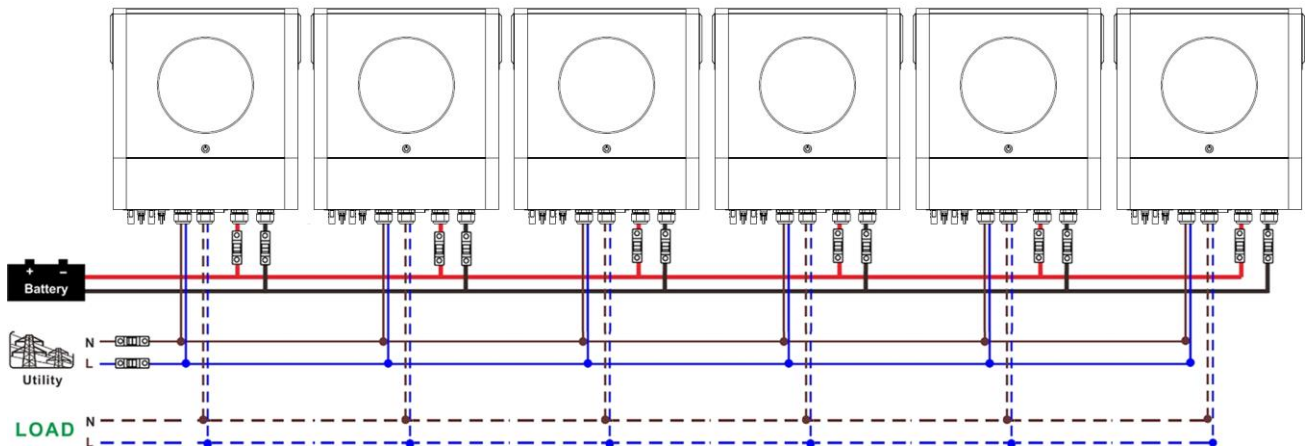

Communication Connection

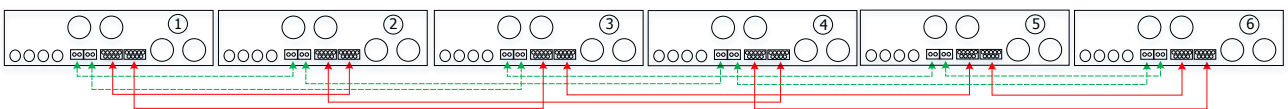

4-2. Support 3-phase equipment

Two inverters in each phase:

Power Connection

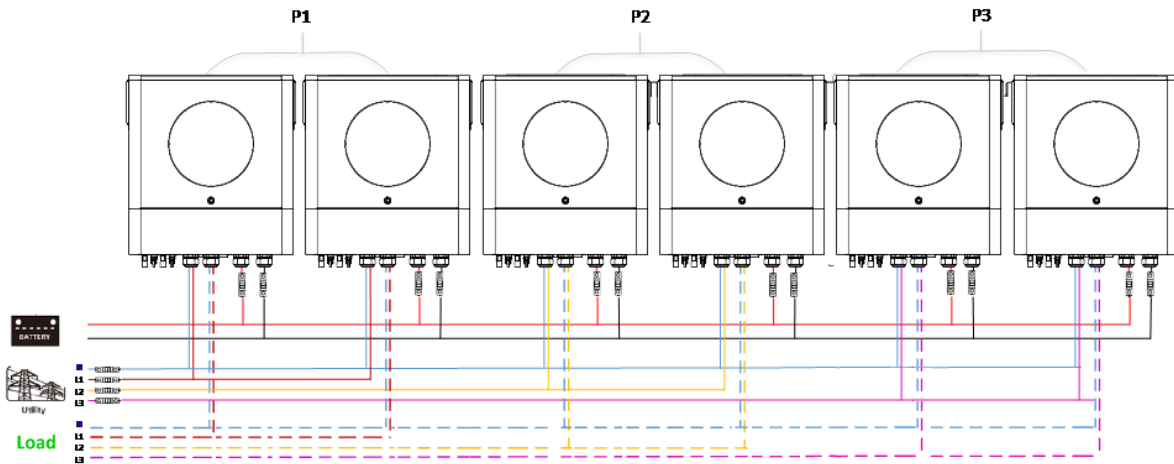

Communication Connection

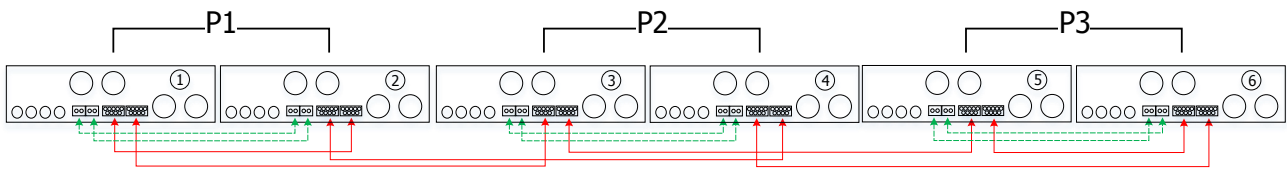

Four inverters in one phase and one inverter for the other two phases:

Power Connection

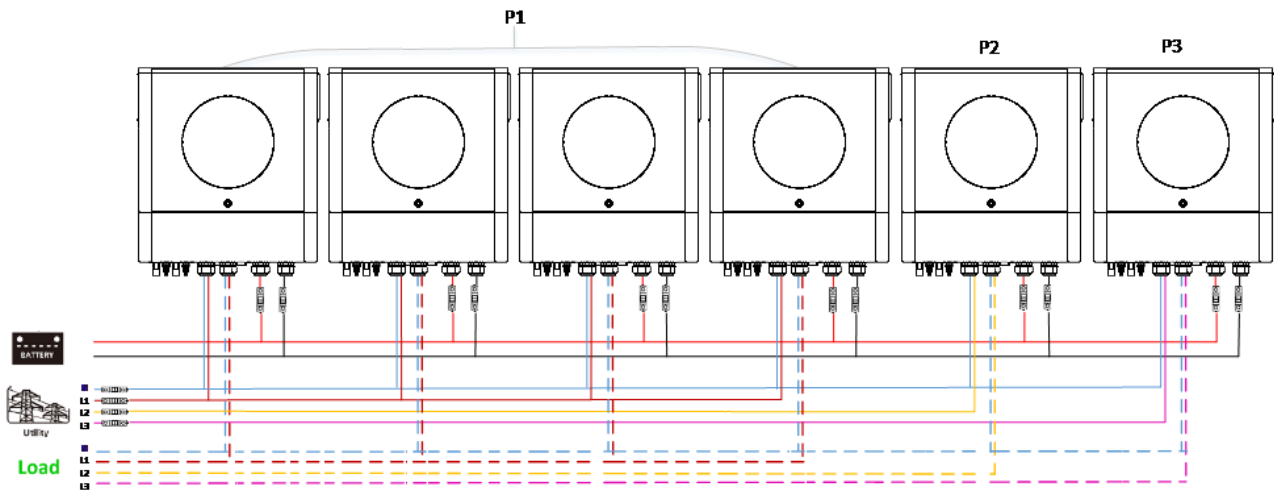

Communication Connection

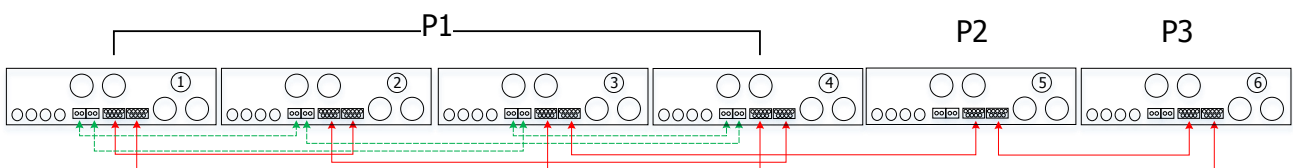

Three inverters in one phase, two inverters in second phase and one inverter for the third phase:

Power Connection

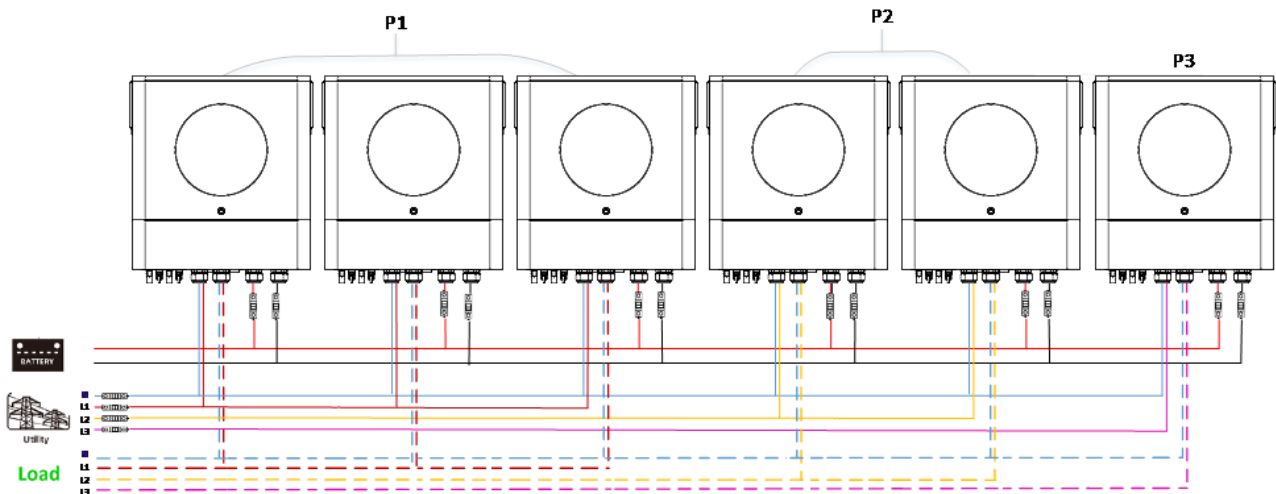

Communication Connection

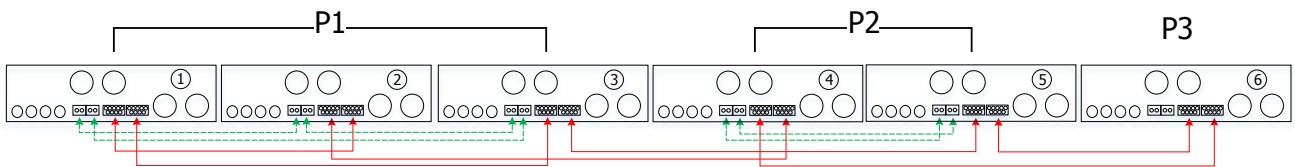

Three inverters in one phase and only one inverter for the remaining two phases:

Power Connection

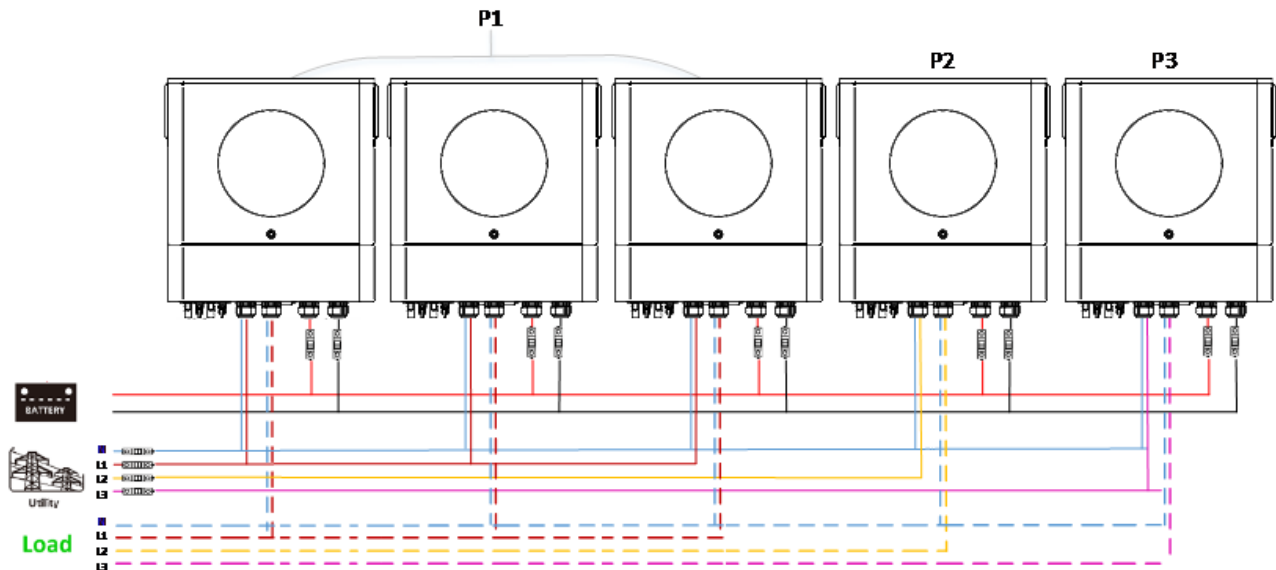

Communication Connection

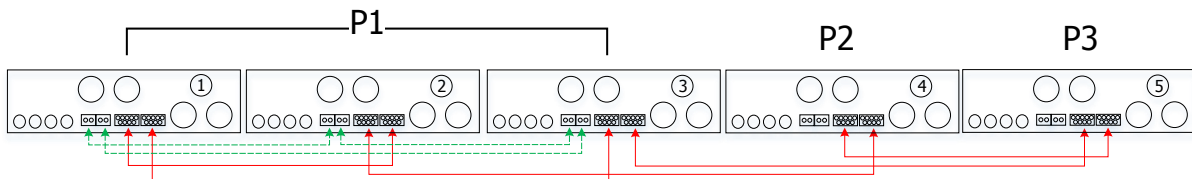

Two inverters in two phases and only one inverter for the remaining phase:

Power Connection

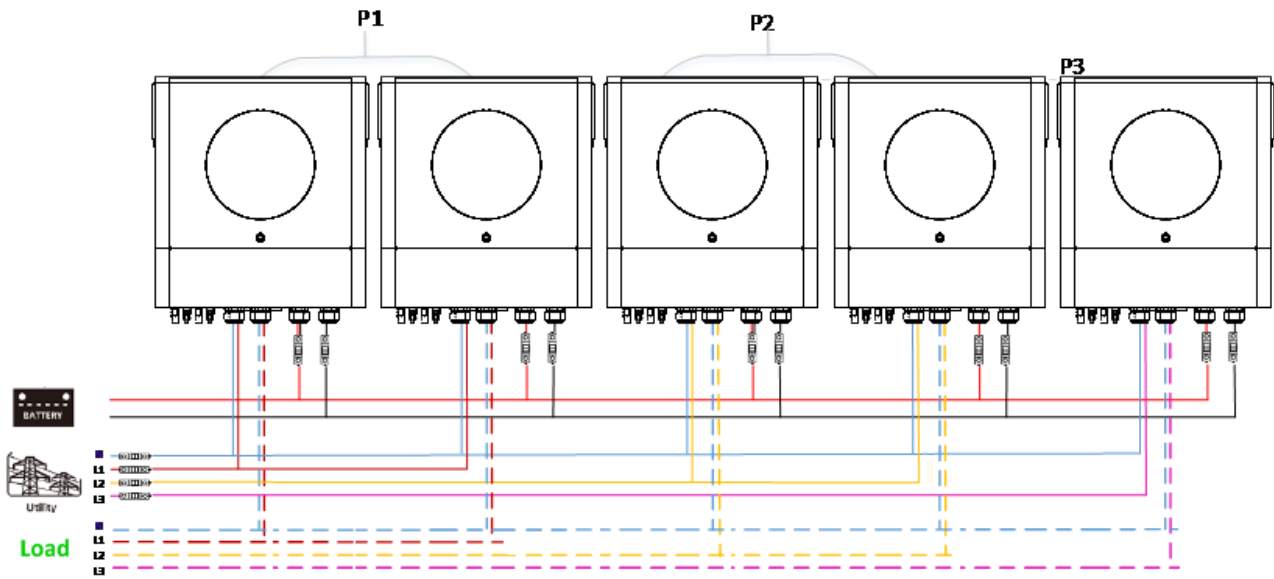

Communication Connection

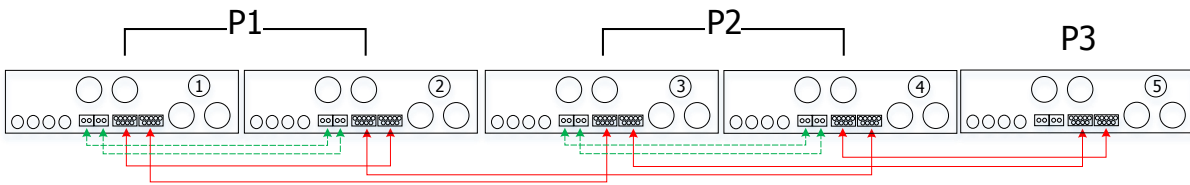

Two inverters in one phase and only one inverter for the remaining phases:

Power Connection

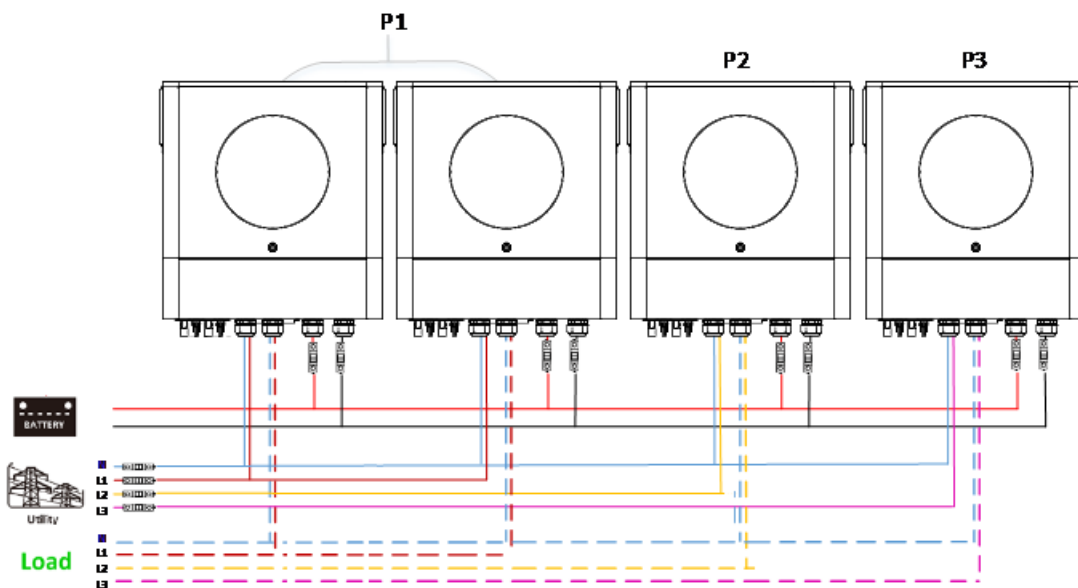

Communication Connection

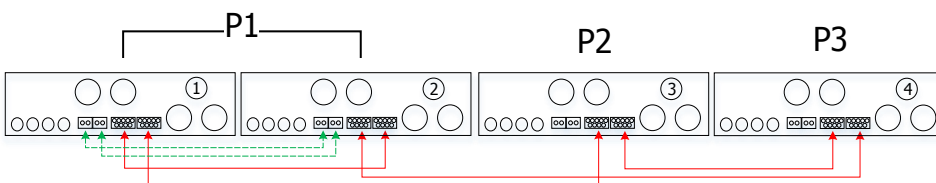

One inverter in each phase:

Power Connection

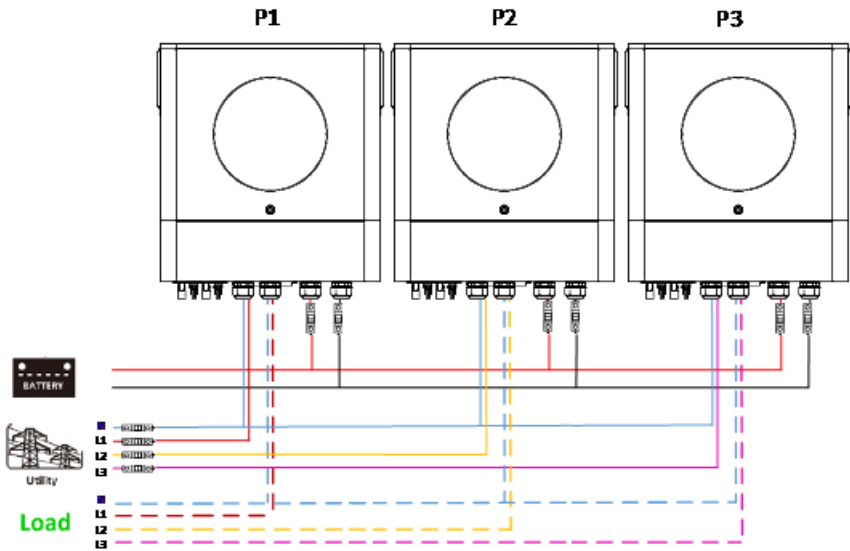

Communication Connection

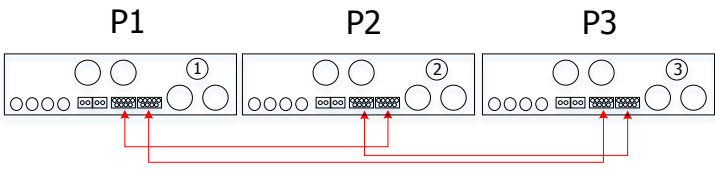

WARNING: Do not connect the current sharing cable between the inverters which are in different phases. Otherwise, it may damage the inverters.

4-3. Support split-phase equipment (only for 6.5KW model)

Three inverters in each phase:

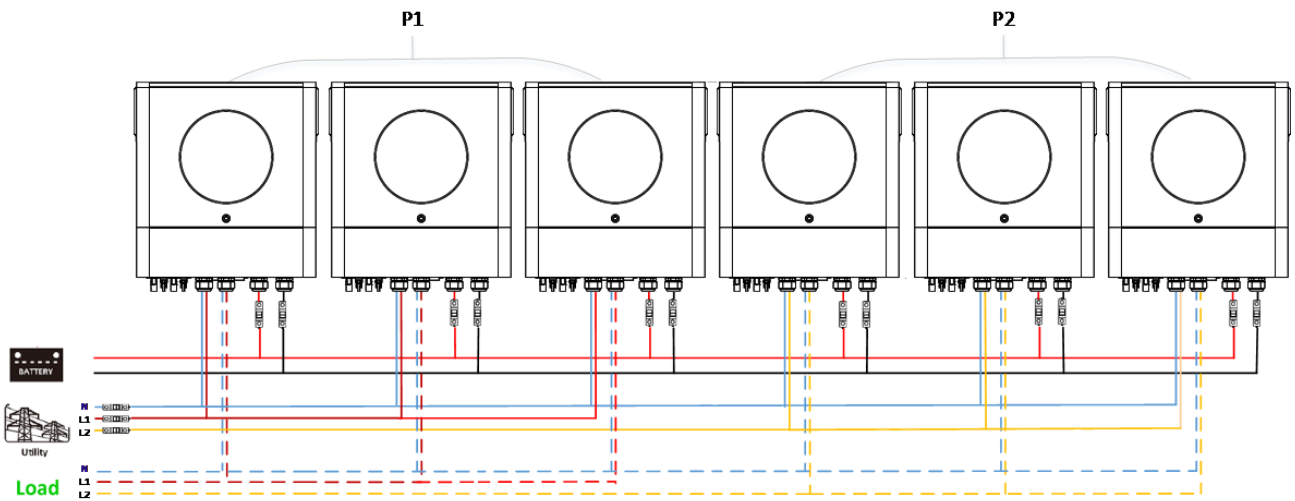

Communication Connection

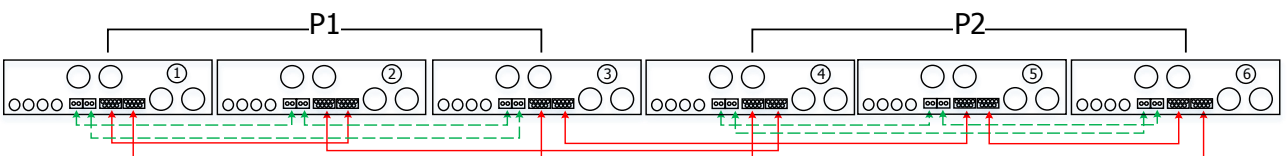

Two inverters in each phase:

Power Connection

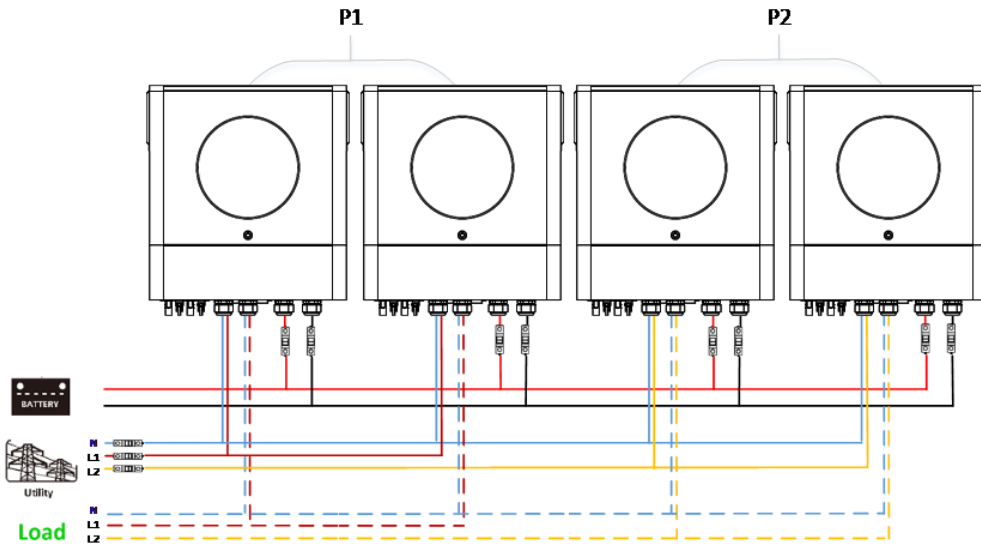

Communication Connection

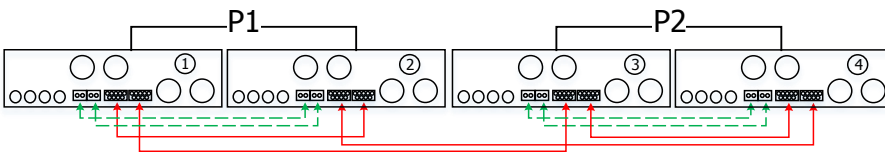

One inverter in each phase:

Power Connection

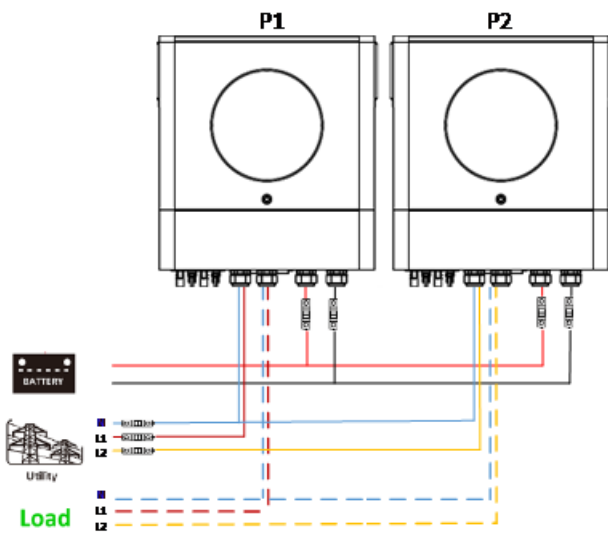

Communication Connection

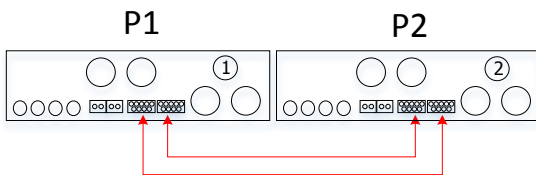

5. PV Connection

Please refer to user manual of single unit for PV Connection.

CAUTION: Each inverter should connect to PV modules separately.

6. LCD Setting and Display

Setting Program:

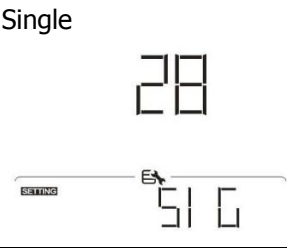
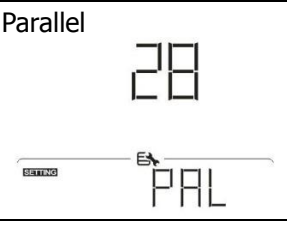
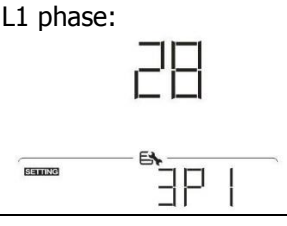
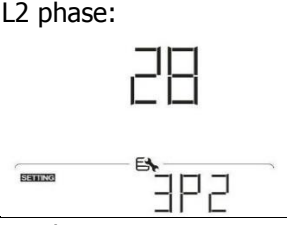
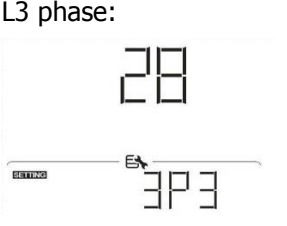
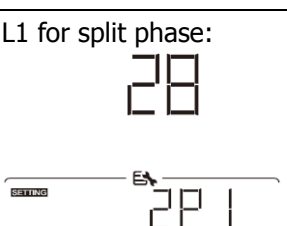
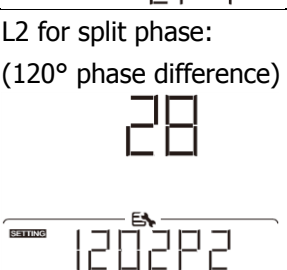
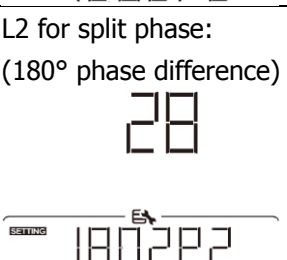
| Program | Description | Selectable option | |
|---------|---|---|---|
| 28 | AC output mode *This setting is able to set up only when the inverter is in standby mode. Be sure that on/off switch is in "OFF" status. | Single  | When the unit is operated alone, please select "SIG" in program 28. |
| | | Parallel  | When the units are used in parallel for single phase application, please select "PAL" in program 28. Please refer to 5-1 for detailed information. |
| | | L1 phase:  | When the units are operated in 3-phase application, please choose "3PX" to define each inverter. It is required to have at least 3 inverters or maximum 6 inverters to support three-phase equipment. It's required to have at least one inverter in each phase or it's up to four inverters in one phase. Please refers to 5-2 for detailed information. Please select "3P1" in program 28 for the inverters connected to L1 phase, "3P2" in program 28 for the inverters connected to L2 phase and "3P3" in program 28 for the inverters connected to L3 phase. |
| | | L2 phase:  | |
| | | L3 phase:  | |
| | | L1 for split phase:  | |
| | | L2 for split phase: (120° phase difference)  | |
| | | L2 for split phase: (180° phase difference)  | Be sure to connect share current cable to units which are on the same phase. Do NOT connect share current cable between units on different phases. |

Fault code display:

| Fault Code | Fault Event | Icon on |
|------------|---|---------|
| 60 | Power feedback protection | F60 |
| 71 | Firmware version inconsistent | F71 |
| 72 | Current sharing fault | F72 |
| 80 | CAN fault | F80 |
| 81 | Host loss | F81 |
| 82 | Synchronization loss | F82 |
| 83 | Battery voltage detected different | F83 |
| 84 | AC input voltage and frequency detected different | F84 |
| 85 | AC output current unbalance | F85 |
| 86 | AC output mode setting is different | F86 |

Code Reference:

| Code | Description | Icon on |
|------|-----------------------------------|---------|
| NE | Unidentified unit master or slave | NE |
| HS | Master unit | HS |
| SL | Slave unit | SL |

7. Commissioning

Parallel in single phase

Step 1: Check the following requirements before commissioning:

- Correct wire connection
- Ensure all breakers in Line wires of load side are open and each Neutral wires of each unit are connected together.

Step 2: Turn on each unit and set "PAL" in LCD setting program 28 of each unit. And then shut down all units.

NOET: It's necessary to turn off switch when setting LCD program. Otherwise, the setting cannot be programmed.

Step 3: Turn on each unit.

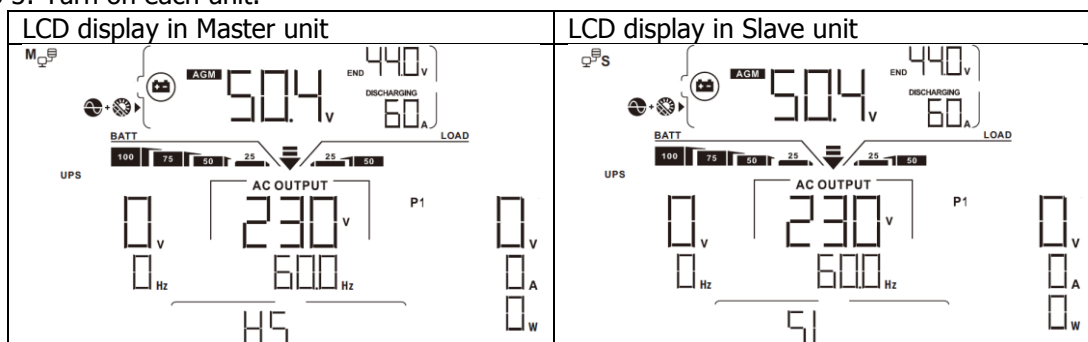

NOTE: Master and slave units are randomly defined.

Step 4: Switch on all AC breakers of Line wires in AC input. It's better to have all inverters connect to utility at the same time. If not, it will display fault 82 in following-order inverters. However, these inverters will automatically restart. If detecting AC connection, they will work normally.

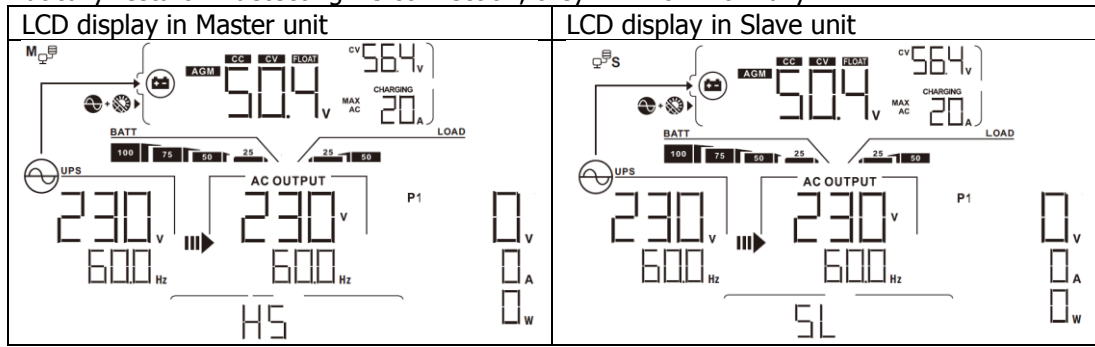

Step 5: If there is no more fault alarm, the parallel system is completely installed.

Step 6: Please switch on all breakers of Line wires in load side. This system will start to provide power to the load.

Support three-phase equipment

Step 1: Check the following requirements before commissioning:

- Correct wire connection
- Ensure all breakers in Line wires of load side are open and each Neutral wires of each unit are connected together.

Step 2: Turn on all units and configure LCD program 28 as P1, P2 and P3 sequentially. And then shut down all units.

NOET: It's necessary to turn off switch when setting LCD program. Otherwise, the setting cannot be programmed.

Step 3: Turn on all units sequentially.

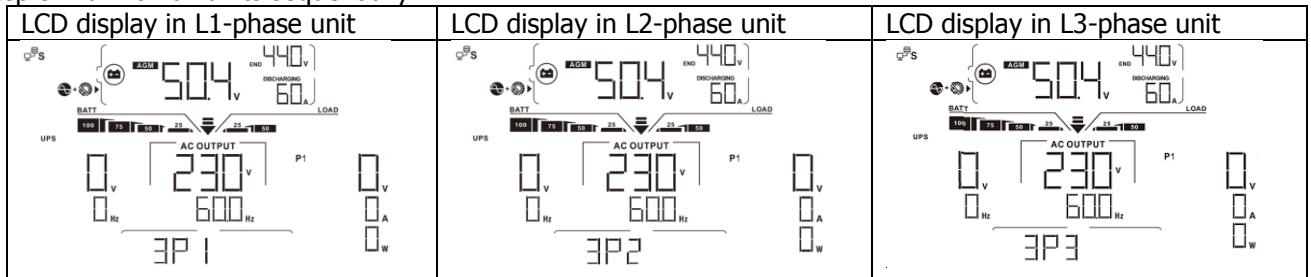

Step 4: Switch on all AC breakers of Line wires in AC input. If AC connection is detected and three phases are matched with unit setting, they will work normally. Otherwise, the AC icon  will flash and they will not work in line mode.

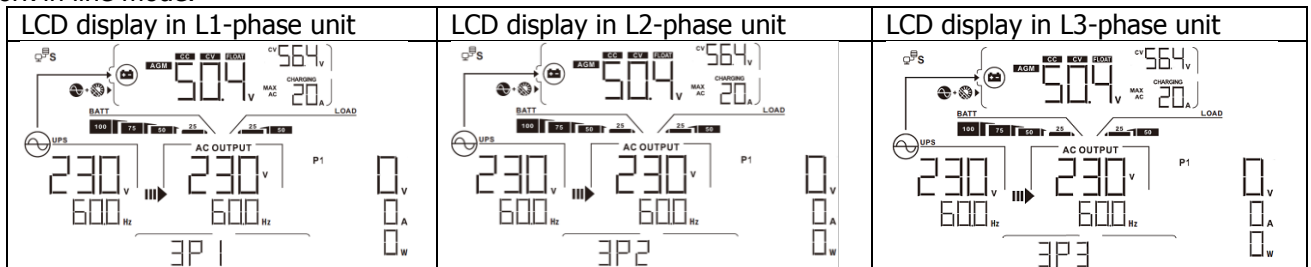

Step 5: If there is no more fault alarm, the system to support 3-phase equipment is completely installed.

Step 6: Please switch on all breakers of Line wires in load side. This system will start to provide power to the load.

Note 1: To avoid overload occurring, before turning on breakers in load side, it's better to have whole system in operation first.

Note 2: Transfer time for this operation exists. Power interruption may happen to critical devices, which cannot bear transfer time.

8. Trouble shooting

| Situation | | Solution |
|------------|--|--|
| Fault Code | Fault Description Event | |
| 60 | Current feedback into the inverter is detected. | <ol style="list-style-type: none"> Restart the inverter. Check if L/N cables are not connected reversely in all inverters. For parallel system in single phase, make sure the sharing are connected in all inverters. For supporting three-phase system, make sure the sharing cables are connected in the inverters in the same phase, and disconnected in the inverters in different phases. If the problem remains, please contact your installer. |
| 71 | The firmware version of each inverter is not the same. | <ol style="list-style-type: none"> Update all inverter firmware to the same version. Check the version of each inverter via LCD setting and make sure the CPU versions are same. If not, please contact your instraller to provide the firmware to update. After updating, if the problem still remains, please contact your installer. |
| 72 | The output current of each inverter is different. | <ol style="list-style-type: none"> Check if sharing cables are connected well and restart the inverter. If the problem remains, please contact your installer. |
| 80 | CAN data loss | <ol style="list-style-type: none"> Check if communication cables are connected well and restart the inverter. If the problem remains, please contact your installer. |
| 81 | Host data loss | |
| 82 | Synchronization data loss | |
| 83 | The battery voltage of each inverter is not the same. | <ol style="list-style-type: none"> Make sure all inverters share same groups of batteries together. Remove all loads and disconnect AC input and PV input. Then, check battery voltage of all inverters. If the values from all inverters are close, please check if all battery cables are the same length and same material type. Otherwise, please contact your installer to provide SOP to calibrate battery voltage of each inverter. If the problem still remains, please contact your installer. |
| 84 | AC input voltage and frequency are detected different. | <ol style="list-style-type: none"> Check the utility wiring connction and restart the inverter. Make sure utility starts up at same time. If there are breakers installed between utility and inverters, please be sure all breakers can be turned on AC input at same time. If the problem remains, please contact your installer. |
| 85 | AC output current unbalance | <ol style="list-style-type: none"> Restart the inverter. Remove some excessive loads and re-check load information from LCD of inverters. If the values are different, please check if AC input and output cables are in the same length and material type. If the problem remains, please contact your installer. |
| 86 | AC output mode setting is different. | <ol style="list-style-type: none"> Switch off the inverter and check LCD setting #28. For parallel system in single phase, make sure no 3P1, 3P2 or 3P3 is set on #28. For upporting three-phase system, make sure no "PAL" is set on #28. If the problem remains, please contact your installer. |

Appendix II: BMS Communication Installation

1. Introduction

If connecting to lithium battery, it is recommended to purchase a custom-made RJ45 communication cable. Please check with your dealer or integrator for details.

This custom-made RJ45 communication cable delivers information and signal between lithium battery and the inverter. These information are listed below:

- Re-configure charging voltage, charging current and battery discharge cut-off voltage according to the lithium battery parameters.
- Have the inverter start or stop charging according to the status of lithium battery.

2. Pin Assignment for BMS Communication Port

| | Definition |
|-------|------------|
| PIN 1 | RS232TX |
| PIN 2 | RS232RX |
| PIN 3 | RS485B |
| PIN 4 | NC |
| PIN 5 | RS485A |
| PIN 6 | CANH |
| PIN 7 | CANL |
| PIN 8 | GND |

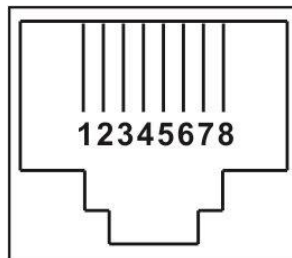

3. Lithium Battery Communication Configuration

LIO-4805/LIO-4810-150A

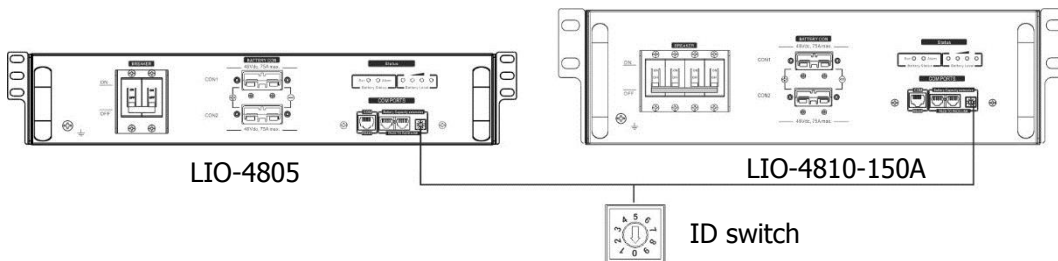

ESS LIO-I 4810

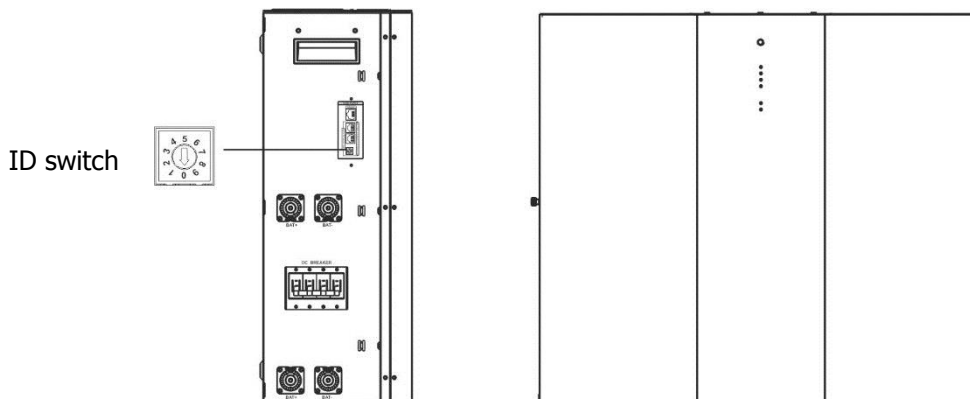

ID Switch indicates the unique ID code for each battery module. It's required to assign an identical ID to each battery module for normal operation. We can set up the ID code for each battery module by rotating the PIN number on the ID switch. From number 0 to 9, the number can be random; no particular order. Maximum 10 battery modules can be operated in parallel.

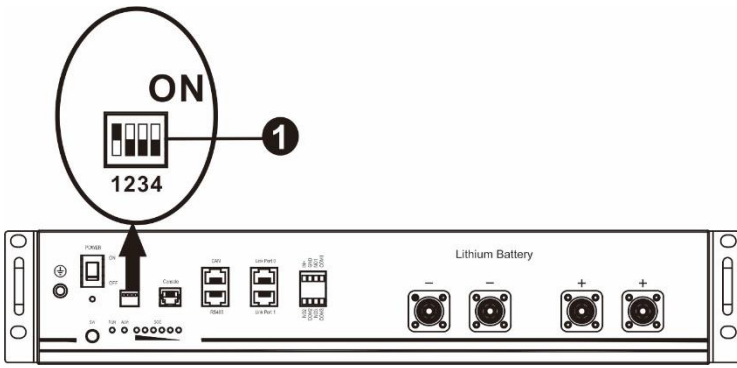

①Dip Switch: There are 4 Dip Switches that sets different baud rate and battery group address. If switch position is turned to the "OFF" position, it means "0". If switch position is turned to the "ON" position, it means "1".

Dip 1 is "ON" to represent the baud rate 9600.

Dip 2, 3 and 4 are reserved for battery group address.

Dip switch 2, 3 and 4 on master battery (first battery) are to set up or change the group address.

NOTE: "1" is upper position and "0" is bottom position.

| Dip 1 | Dip 2 | Dip 3 | Dip 4 | Group address |
|---|-------|-------|-------|--|
| 1: RS485 baud rate=9600 Restart to take effect | 0 | 0 | 0 | Single group only. It's required to set up master battery with this setting and slave batteries are unrestricted. |
| | 1 | 0 | 0 | Multiple group condition. It's required to set up master battery on the first group with this setting and slave batteries are unrestricted. |
| | 0 | 1 | 0 | Multiple group condition. It's required to set up master battery on the second group with this setting and slave batteries are unrestricted. |
| | 1 | 1 | 0 | Multiple group condition. It's required to set up master battery on the third group with this setting and slave batteries are unrestricted. |
| | 0 | 0 | 1 | Multiple group condition. It's required to set up master battery on the fourth group with this setting and slave batteries are unrestricted. |
| | 1 | 0 | 1 | Multiple group condition. It's required to set up master battery on the fifth group with this setting and slave batteries are unrestricted. |

NOTE: The maximum groups of lithium battery is 5 and for maximum number for each group, please check with battery manufacturer.

4. Installation and Operation

LIO-4805/LIO-4810-150A/ESS LIO-I 4810

After ID no. is assigned for each battery module, please set up LCD panel in inverter and install the wiring connection as following steps.

Step 1: Use supplied RJ11 signal cable to connect into the extension port (P1 or P2).

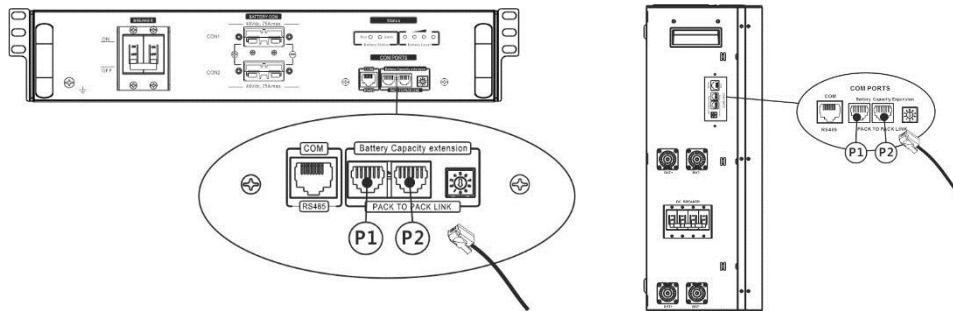

Step 2: Use supplied RJ45 cable (from battery module package) to connect inverter and Lithium battery.

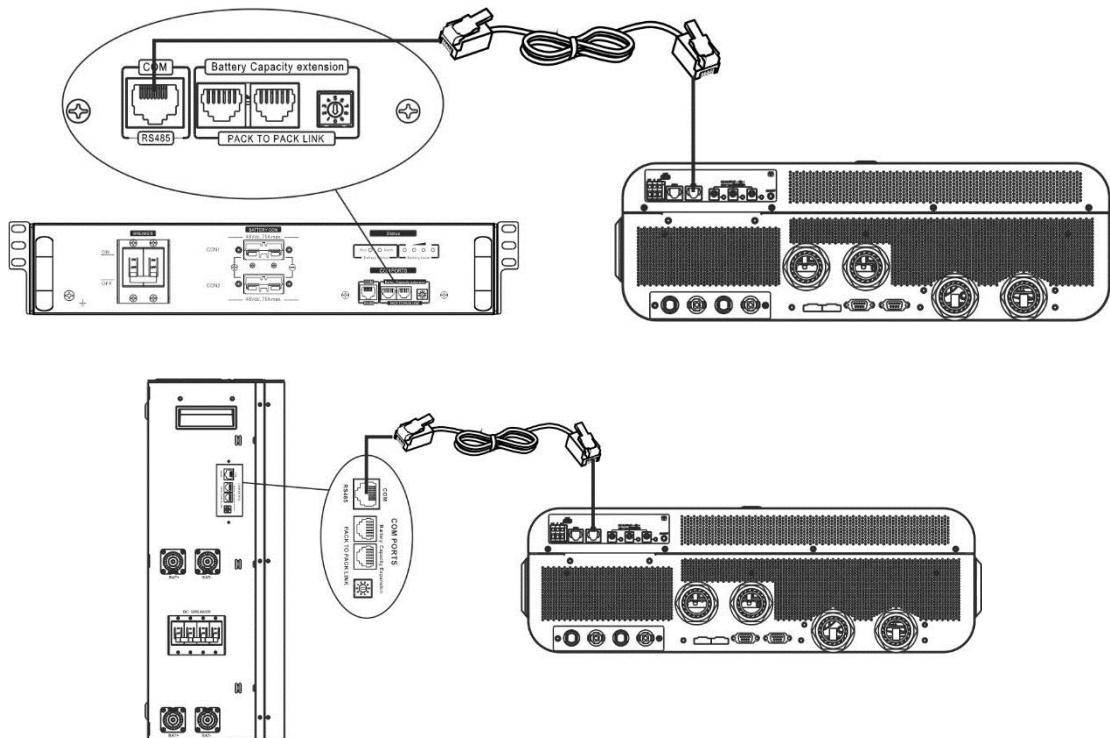

Note for parallel system:

1. Only support common battery installation.
2. Use custom-made RJ45 cable to connect any inverter (no need to connect to a specific inverter) and Lithium battery. Simply set this inverter battery type to "LIB" in LCD program 5. Others should be "USE".

Step 3: Turn the breaker switch "ON". Now, the battery module is ready for DC output.



Step 4: Press Power on/off button on battery module for 5 secs, the battery module will start up.

*If the manual button cannot be approached, just simply turn on the inverter module. The battery module will be automatically turned on.

Step 5: Turn on the inverter.

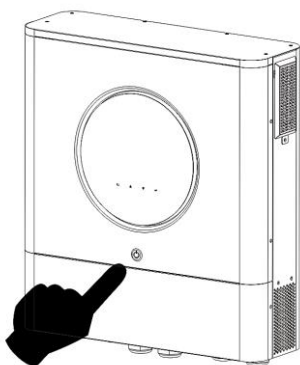

Step 6. Be sure to select battery type as "LIB" in LCD program 5.

05



If communication between the inverter and battery is successful, the battery icon on LCD display will flash. Generally speaking, it will take longer than 1 minute to establish communication.

PYLONTECH

After configuration, please install LCD panel with inverter and Lithium battery with the following steps.

Step 1. Use custom-made RJ45 cable to connect inverter and Lithium battery.

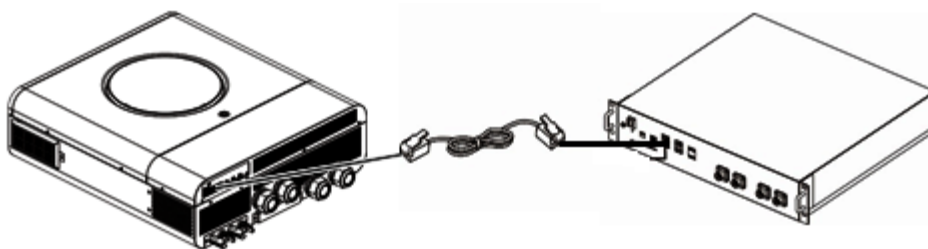

Note for parallel system:

- 3. Only support common battery installation.
- 4. Use custom-made RJ45 cable to connect any inverter (no need to connect to a specific inverter) and Lithium battery. Simply set this inverter battery type to "PYL" in LCD program 5. Others should be "USE".

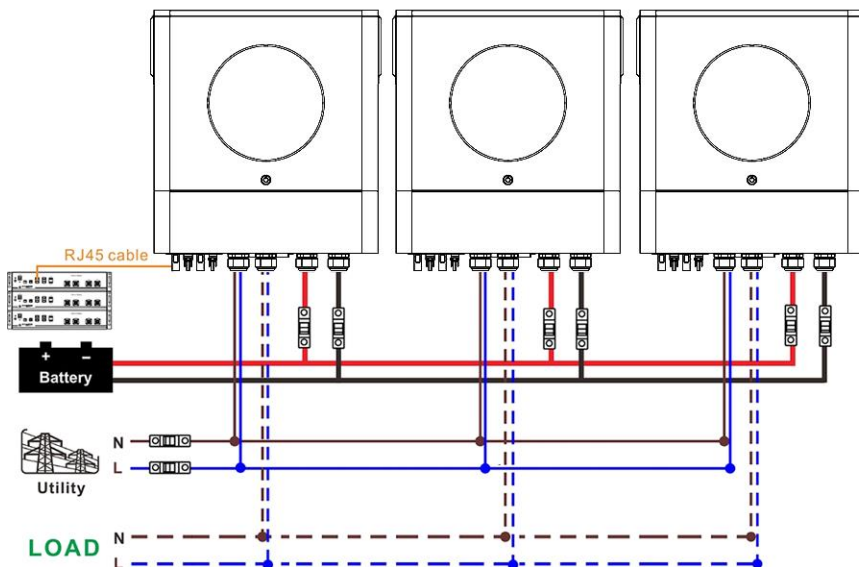

Step 2. Switch on Lithium battery.

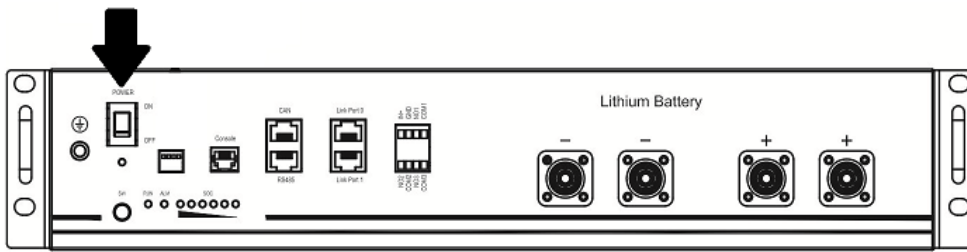

Step 3. Press more than three seconds to start Lithium battery, power output ready.

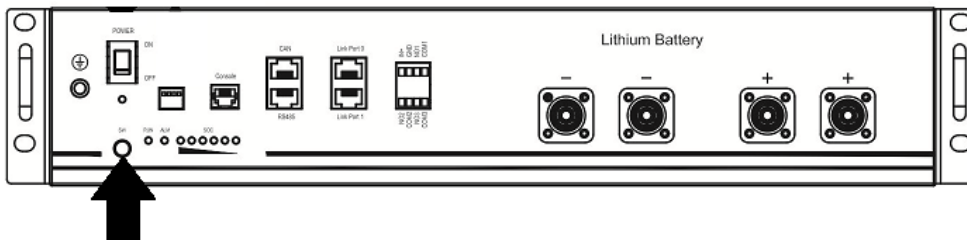

Step 4. Turn on the inverter.

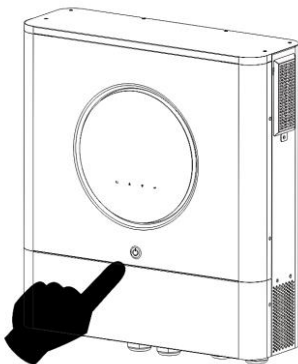

Step 5. Be sure to select battery type as "PYL" in LCD program 5.

05



If communication between the inverter and battery is successful, the battery icon  on LCD display will flash. Generally speaking, it will take longer than 1 minute to establish communication.

WECO

Step 1. Use a custom-made RJ45 cable to connect inverter and Lithium battery.

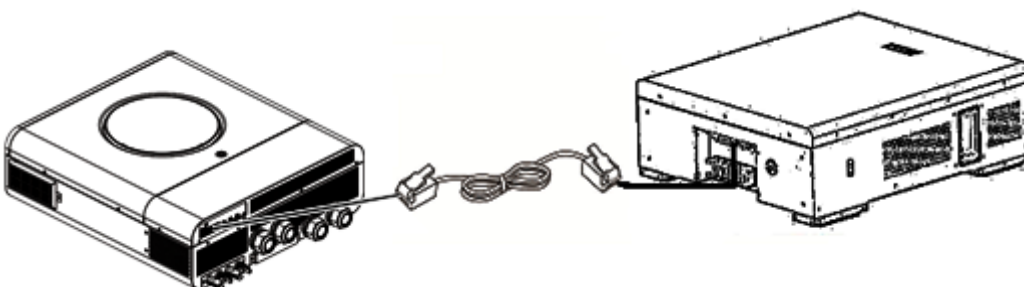

Please take notice for parallel system:

1. Only support common battery installation.
2. Use one custom-made RJ45 cable to connect any inverter (no need to connect to a specific inverter) and Lithium battery. Simply set battery type of this inverter to "WEC" in LCD program 5. The remaining inverters are set as "USE".

Step 2. Switch on Lithium battery.

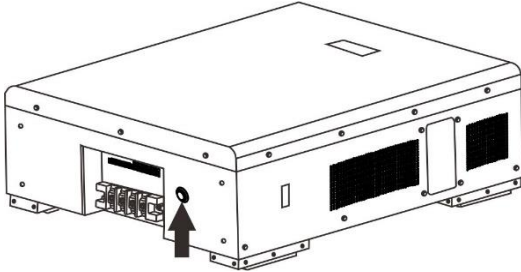

Step 3. Turn on the inverter.

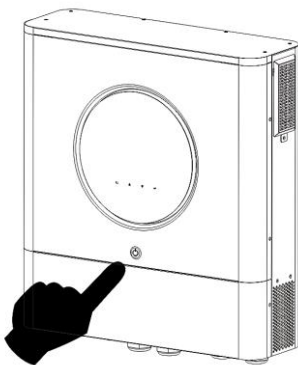

Step 4. Be sure to select battery type as "WEC" in LCD program 5.

05



If communication between the inverter and battery is successful, the battery icon  on LCD display will "flash". Generally speaking, it will take longer than 1 minute to establish communication.

SOLTARO

Step 1. Use a custom-made RJ45 cable to connect inverter and Lithium battery.

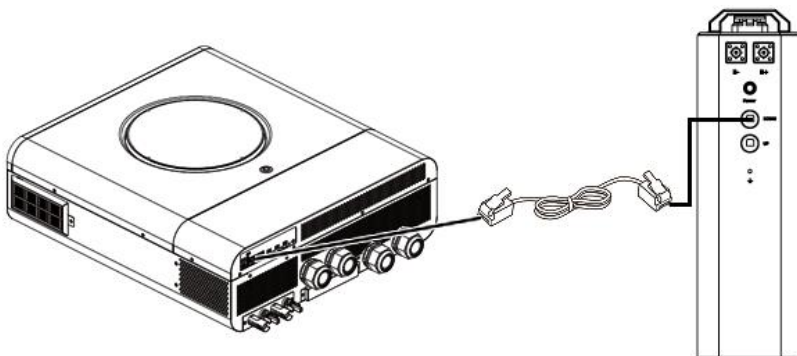

Please take notice for parallel system:

1. Only support common battery installation.

2. Use one custom-made RJ45 cable to connect any inverter (no need to connect to a specific inverter) and Lithium battery. Simply set battery type of this inverter to "SOL" in LCD program 5. The remaining inverters are set as "USE".

Step 2. Open DC isolator and switch on Lithium battery.

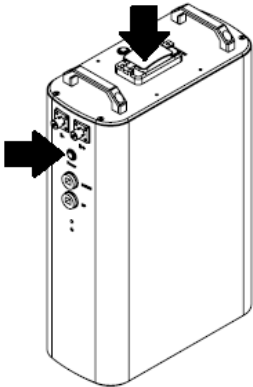

Step 3. Turn on the inverter.

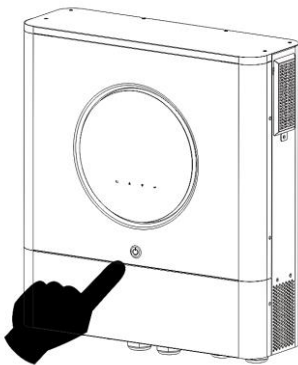

Step 4. Be sure to select battery type as "SOL" in LCD program 5.

05



If communication between the inverter and battery is successful, the battery icon  on LCD display will "flash". Generally speaking, it will take longer than 1 minute to establish communication.

Active Function

This function is to activate lithium battery automatically while commissioning. After battery wiring and commissioning is successfully, if battery is not detected, the inverter will automatically activate battery if the inverter is powered on.

4. LCD Display Information

Press "▲" or "▼" button to switch LCD display information. It will show battery pack and battery group number before "Main CPU version checking" as shown below.

| Selectable information | LCD display |
|--|--|
| Battery pack numbers & Battery group numbers | <p>Battery pack numbers = 3, battery group numbers = 1</p> <p>The LCD display shows various parameters: a battery icon with 'AGM' and '50.4 V', 'END 44.0 V', and 'DISCHARGING 20 A'. Below this is a 'BATT' bar chart and a 'LOAD' bar chart. The 'AC OUTPUT' section shows '230 V', '500 Hz', and 'P1'. At the bottom, it displays 'PO3601'.</p> |

5. Code Reference

Related information code will be displayed on LCD screen. Please check inverter LCD screen for the operation.

| Code | Description |
|------|---|
| 60 | If battery status is not allowed to charge and discharge after the communication between the inverter and battery is successful, it will show code 60 to stop charging and discharging battery. |
| 61 | <p>Communication lost (only available when the battery type is not setting as "AGM", "Flooded" or "User-Defined".)</p> <ul style="list-style-type: none"> After battery is connected, communication signal is not detected for 3 minutes, buzzer will beep. After 10 minutes, inverter will stop charging and discharging to lithium battery. Communication lost occurs after the inverter and battery is connected successfully, buzzer beeps immediately. |
| 69 | If battery status is not allowed to charge after the communication between the inverter and battery is successful, it will show code 69 to stop charging battery. |
| 70 | If battery status must be charged after the communication between the inverter and battery is successful, it will show code 70 to charge battery. |
| 71 | If battery status is not allowed to discharge after the communication between the inverter and battery is successful, it will show code 71 to stop discharging battery. |

Appendix III: The Wi-Fi Operation Guide

1. Introduction

Wi-Fi module can enable wireless communication between off-grid inverters and monitoring platform. Users have complete and remote monitoring and controlling experience for inverters when combining Wi-Fi module with WatchPower APP, available for both iOS and Android based device. All data loggers and parameters are saved in iCloud.

The major functions of this APP:

- Delivers device status during normal operation.
- Allows to configure device setting after installation.
- Notifies users when a warning or alarm occurs.
- Allows users to query inverter history data.

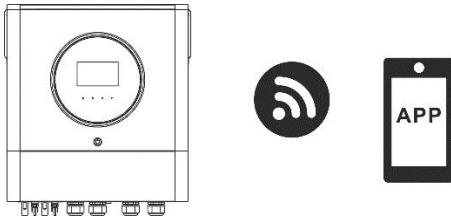

2. WatchPower App

2-1. Download and install APP

Operating system requirement for your smart phone:

🍏 iOS system supports iOS 9.0 and above

🤖 Android system supports Android 5.0 and above

Please scan the following QR code with your smart phone and download WatchPower App.



Android system





iOS system

Or you may find "WatchPower" app from the Apple® Store or "WatchPower Wi-Fi" in Google® Play Store.



2-2. Initial Setup

Step 1: Registration at first time

After the installation, please tap the shortcut icon  to access this APP on your mobile screen. In the screen, tap "Register" to access "User Registration" page. Fill in all required information and scan the Wi-Fi module PN by tapping  icon. Or you can simply enter PN directly. Then, tap "Register" button.

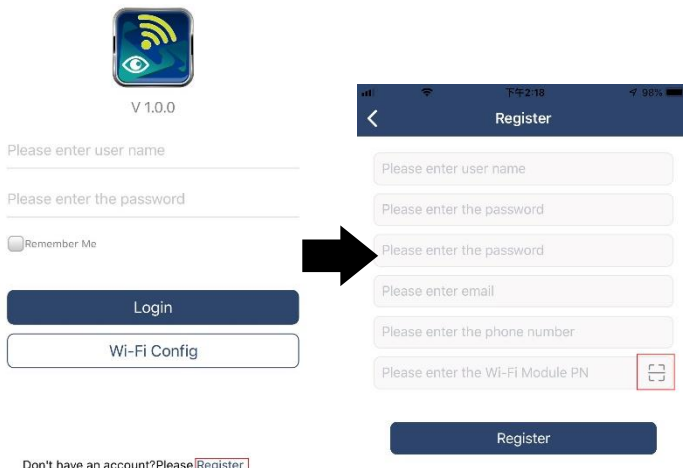

Then, a "Registration success" window will pop up. Tap "Go now" to continue setting local Wi-Fi network connection.

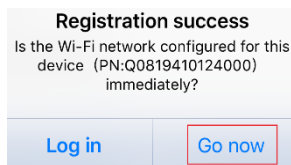

Step 2: Local Wi-Fi Module Configuration

Now, you are in "Wi-Fi Config" page. There are detailed setup procedure listed in "How to connect?" section and you may follow it to connect Wi-Fi.

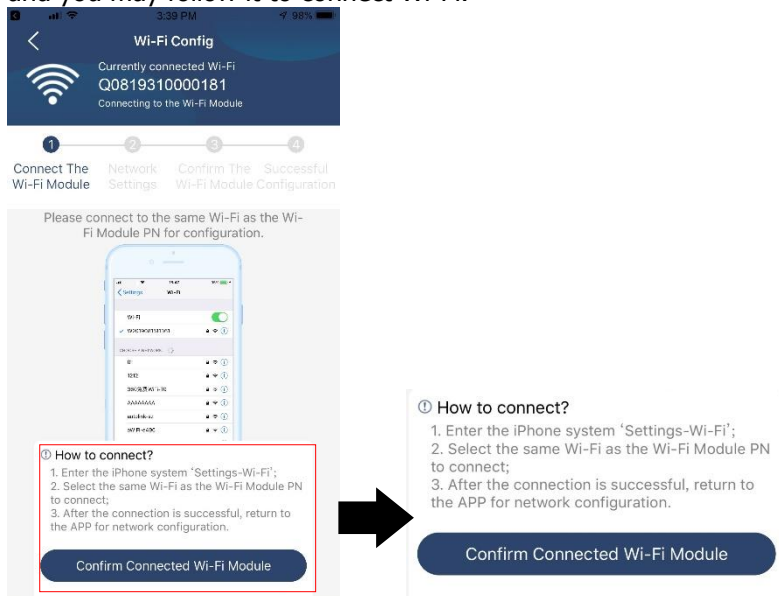

Enter the "Settings→Wi-Fi" and select connected Wi-Fi name. The connected Wi-Fi name is the same to your Wi-Fi PN number and enter default password "12345678".

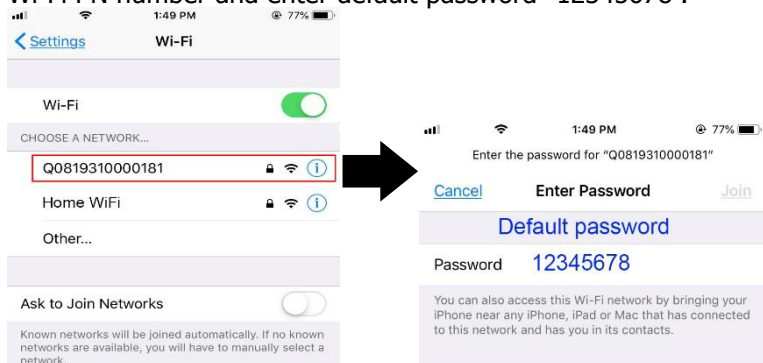

Then, return to WatchPower APP and tap "Confirm Connected Wi-Fi Module" button when Wi-Fi module is connected successfully.

Step 3: Wi-Fi Network settings

Tap icon to select your local Wi-Fi router name (to access the internet) and enter password.

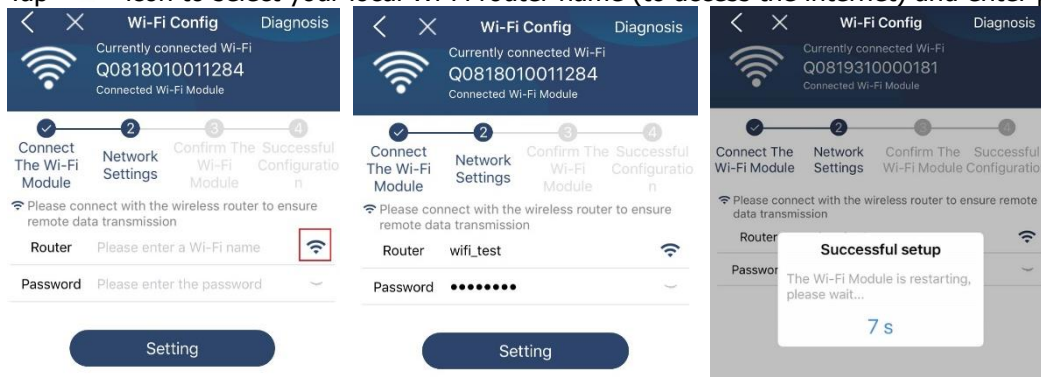

Step 4: Tap "Confirm" to complete the Wi-Fi configuration between the Wi-Fi module and the Internet.

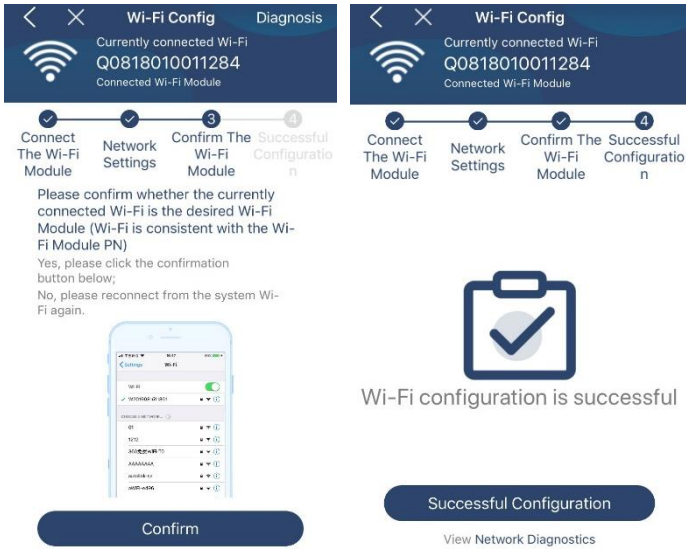

If the connection fails, please repeat Step 2 and 3.

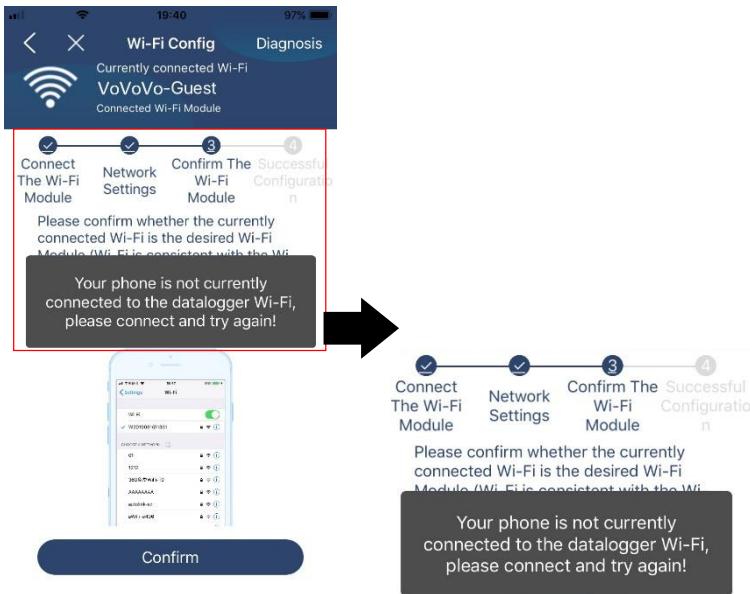

Diagnose Function

If the module is not monitoring properly, please tap "Diagnosis" on the top right corner of the screen for further details. It will show repair suggestion. Please follow it to fix the problem. Then, repeat the steps in the chapter 4.2 to re-set network setting. After all setting, tap "Rediagnosis" to re-connect again.

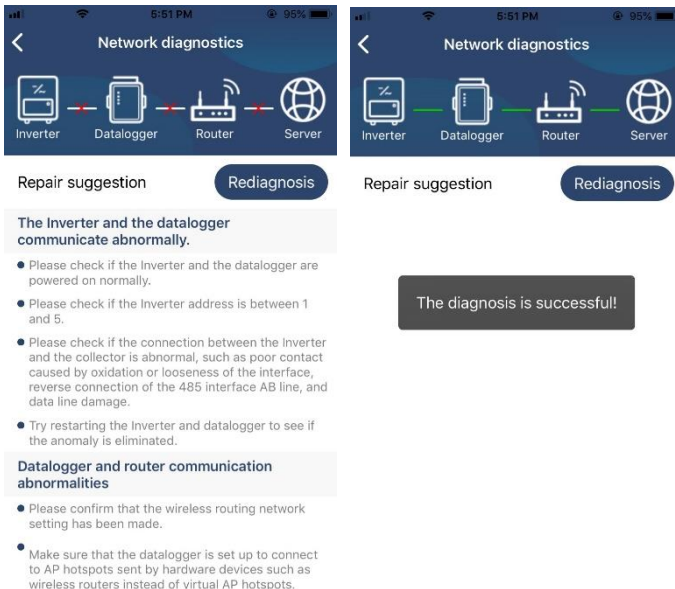

2-3. Login and APP Main Function

After finishing the registration and local Wi-Fi configuration, enter registered name and password to login.
Note: Tick "Remember Me" for your login convenience afterwards.

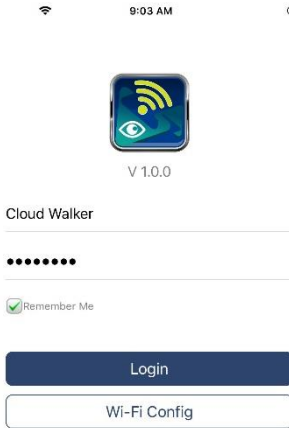

Overview

After login is successfully, you can access "Overview" page to have overview of your monitoring devices, including overall operation situation and Energy information for Current power and Today power as below diagram.

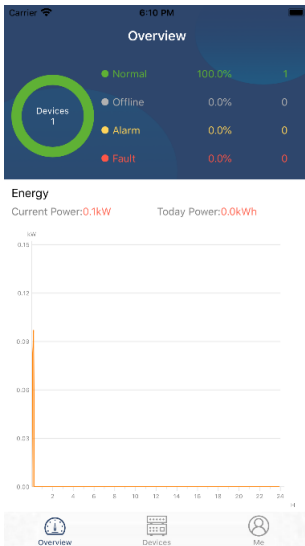

Devices

Tap the  icon (located on the bottom) to enter Device List page. You can review all devices here by adding or deleting Wi-Fi Module in this page.

Add device



Delete device

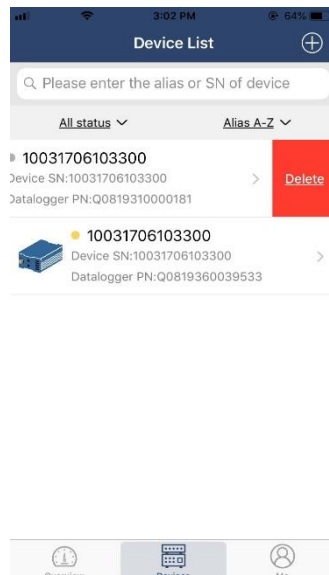

Tap  icon on the top right corner and manually enter part number to add device. This part number label is pasted on the bottom of inverter. After entering part number, tap "Confirm" to add this device in the Device list.

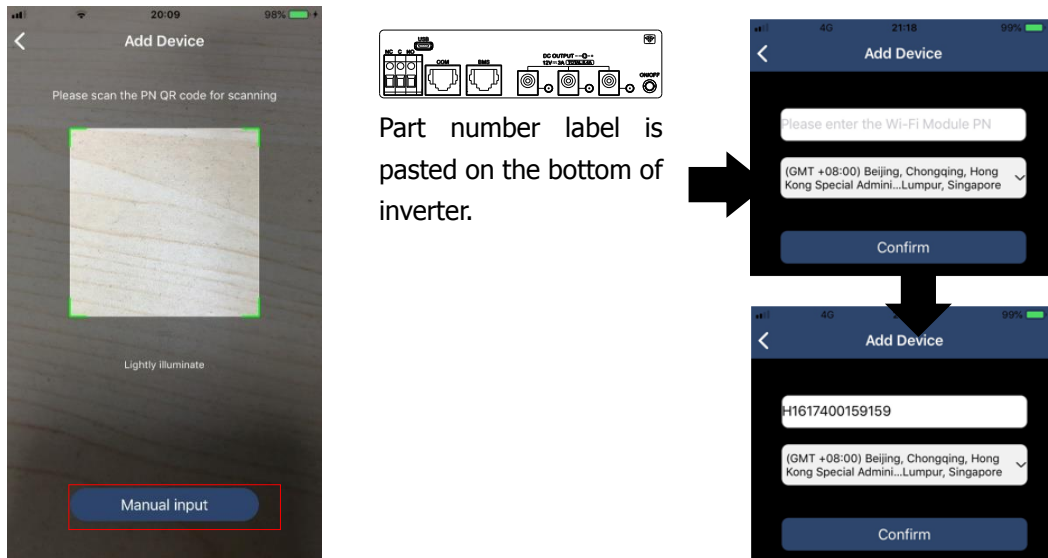

For more information about Device List, please refer to the section 2.4.

ME

In ME page, users can modify "My information", including **【User's Photo】**, **【Account security】**, **【Modify password】**, **【Clear cache】**, and **【Log-out】**, shown as below diagrams.

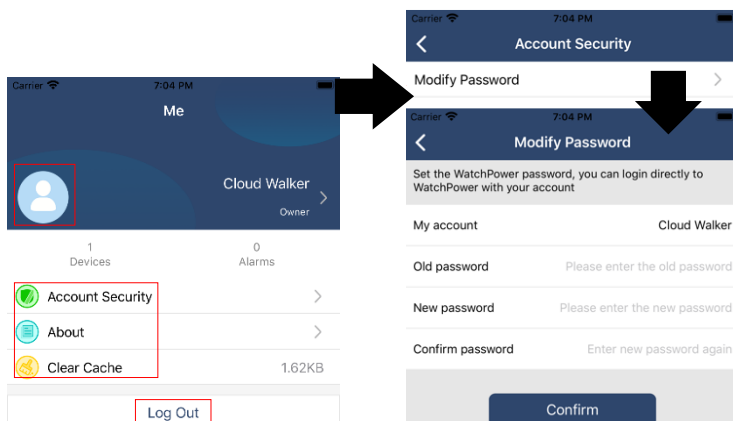

2-4. Device List

In Device List page, you can pull down to refresh the device information and then tap any device you want to check up for its real-time status and related information as well as to change parameter settings. Please refer to the parameter setting list.

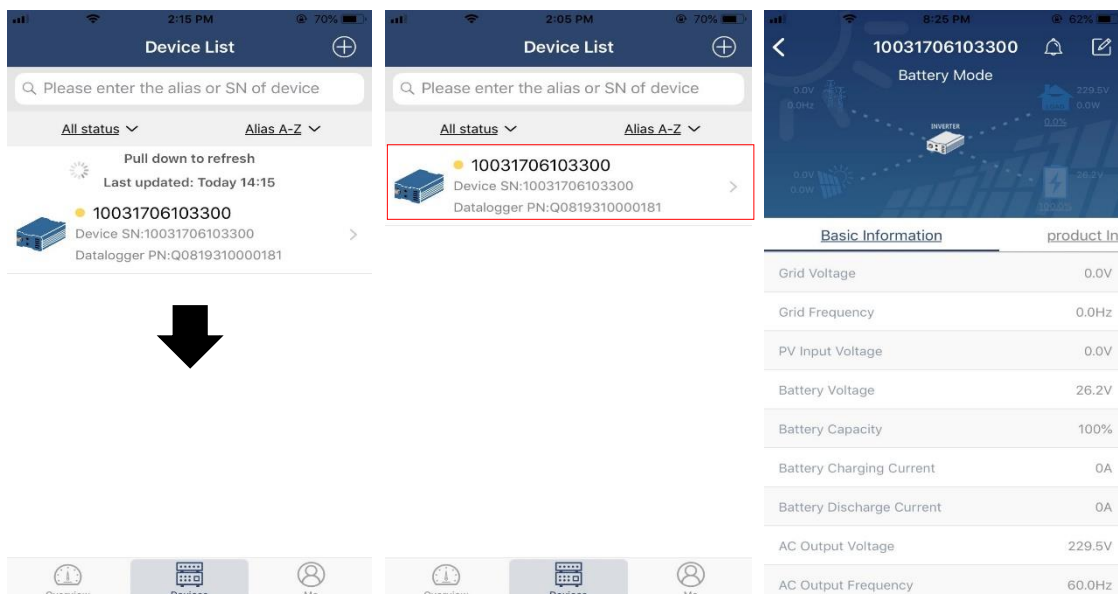

Device Mode

On the top of screen, there is a dynamic power flow chart to show live operation. It contains five icons to present PV power, inverter, load, utility and battery. Based on your inverter model status, there will be **【Standby Mode】** , **【Line Mode】** , **【Battery Mode】** .

【Standby Mode】 Inverter will not power the load until “ON” switch is pressed. Qualified utility or PV source can charge battery in standby mode.



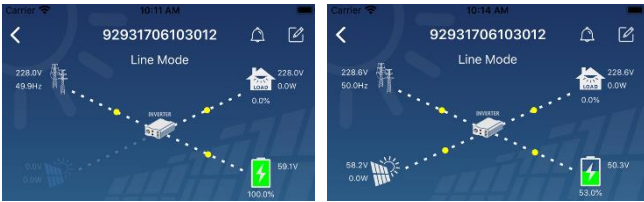

【Line Mode】 Inverter will power the load from the utility with or without PV charging. Qualified utility or PV source can charge battery.

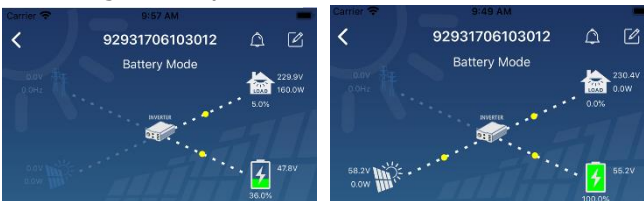

【Battery Mode】 Inverter will power the load from the batter with or without PV charging. Only PV source can charge battery.



Device Alarm and Name Modification

In this page, tap the  icon on the top right corner to enter the device alarm page. Then, you can review alarm history and detailed information. Tap the  icon on the top right corner, a blank input box will pop out. Then, you can edit the name for your device and tap “Confirm” to complete name modification.

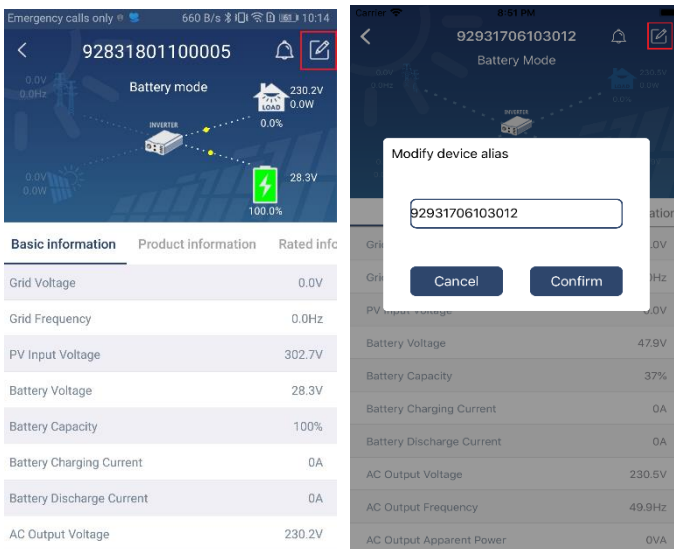

Device Information Data

Users can check up **【Basic Information】**, **【Product Information】**, **【Rated information】**, **【History】**, and **【Wi-Fi Module Information】** by swiping left.



Basic Information product Info

| | |
|---------------------------|--------|
| Grid Voltage | 0.0V |
| Grid Frequency | 0.0Hz |
| PV Input Voltage | 0.0V |
| Battery Voltage | 26.2V |
| Battery Capacity | 100% |
| Battery Charging Current | 0A |
| Battery Discharge Current | 0A |
| AC Output Voltage | 229.5V |
| AC Output Frequency | 60.0Hz |



Swipe left

【Basic Information】 displays basic information of the inverter, including AC voltage, AC frequency, PV input voltage, Battery voltage, Battery capacity, Charging current, Output voltage, Output frequency, Output apparent power, Output active power and Load percent. Please slide up to see more basic information.

【Production Information】 displays Model type (Inverter type), Main CPU version, Bluetooth CPU version and secondary CPU version.

【Rated Information】 displays information of Nominal AC voltage, Nominal AC current, Rated battery voltage, Nominal output voltage, Nominal output frequency, Nominal output current, Nominal output apparent power and Nominal output active power. Please slide up to see more rated information.

【History】 displays the record of unit information and setting timely.

【Wi-Fi Module Information】 displays of Wi-Fi Module PN, status and firmware version.

Parameter Setting

This page is to activate some features and set up parameters for inverters. Please be noted that the listing in "Parameter Setting" page in below diagram may differ from the models of monitored inverter. Here will briefly highlight some of it, **【Output Setting】**, **【Battery Parameter Setting】**, **【Enable/ Disable items】**, **【Restore to the defaults】** to illustrate.

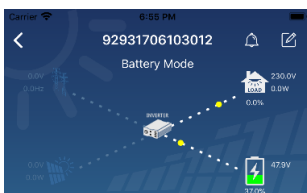

y Parameter Setting Wi-Fi Mod

| | |
|----------------------------|---|
| Output Setting | > |
| Battery Parameter Setting | > |
| Enable/Disable items | > |
| Restore to the defaults | > |
| Time zone setting | > |
| Wi-Fi Module configuration | > |

There are three ways to modify setting and they vary according to each parameter.

- Listing options to change values by tapping one of it.
 - Activate/Shut down functions by clicking "Enable" or "Disable" button.
 - Changing values by clicking arrows or entering the numbers directly in the column.
- Each function setting is saved by clicking "Set" button.

Please refer to below parameter setting list for an overall description and be noted that the available parameters may vary depending on different models. Please always see the original product manual for detailed setting instructions.

Parameter setting list:

| Item | | Description |
|---------------------------|---|---|
| Output setting | Output source priority | To configure load power source priority. |
| | AC input range | When selecting "UPS", it's allowed to connect personal computer. Please check product manual for details. |
| | | When selecting "Appliance", it's allowed to connect home appliances. |
| | Output voltage | To set output voltage. |
| Output frequency | To set output frequency. | |
| Battery parameter setting | Battery type: | To set connected battery type. |
| | Battery cut-off voltage | To set the battery stop discharging voltage. Please see product manual for the recommended voltage range based on connected battery type. |
| | Back to grid voltage | When "SBU" or "SOL" is set as output source priority and battery voltage is lower than this setting voltage, unit will transfer to line mode and the grid will provide power to load. |
| | Back to discharge voltage | When "SBU" or "SOL" is set as output source priority and battery voltage is higher than this setting voltage, battery will be allowed to discharge. |
| | Charger source priority: | To configure charger source priority. |
| | Max. charging current | It's to set up battery charging parameters. The selectable values in different inverter model may vary. Please see product manual for the details. |
| | Max. AC charging current: | |
| | Float charging voltage | |
| | Bulk charging voltage | It's to set up battery charging parameters. The selectable values in different inverter model may vary. Please see product manual for the details. |
| | Battery equalization | Enable or disable battery equalization function. |
| | Real-time Activate Battery Equalization | It's real-time action to activate battery equalization. |
| | Equalized Time Out | To set up the duration time for battery equalization. |
| | Equalized Time | To set up the extended time to continue battery equalization. |
| | Equalization Period | To set up the frequency for battery equalization. |
| Equalization Voltage | To set up the battery equalization voltage. | |

| | | |
|--------------------------|--|--|
| Enable/Disable Functions | LCD Auto-return to Main screen | If enable, LCD screen will return to its main screen after one minute automatically. |
| | Fault Code Record | If enabled, fault code will be recorded in the inverter when any fault happens. |
| | Backlight | If disabled, LCD backlight will be off when panel button is not operated for 1 minute. |
| | Bypass Function | If enabled, unit will transfer to line mode when overload happened in battery mode. |
| | Beeps while primary source interrupt | If enabled, buzzer will alarm when primary source is abnormal. |
| | Over Temperature Auto Restart | If disabled, the unit won't be restarted after over-temperature fault is solved. |
| | Overload Auto Restart | If disabled, the unit won't be restarted after overload occurs. |
| | Buzzer | If disabled, buzzer won't be on when alarm/fault occurred. |
| RGB LED Setting | Enable/disable | Turn on or off RGB LEDs |
| | Brightness | Adjust the lighting brightness |
| | Speed | Adjust the lighting speed |
| | Effects | Change the light effects |
| | Color Selection | Adjust color by setting RGB value |
| Restore to the default | This function is to restore all settings back to default settings. | |