



PYLONTECH

Lithium-Ion Phosphate Energy Storage System PowerCube-M1 Operation Manual

Information Version: 2.2
19PIMV1003

This manual introduces PowerCube-M1 from Pylontech. PowerCube-M1 is a high voltage Lithium-Ion Phosphate Battery storage system. Please read this manual before you install the battery and follow the instruction carefully during the installation process. Any confusion, please contact Pylontech immediately for advice and clarification.

Content

1. SAFETY.....	1
1.1 Symbol.....	1
2. SYSTEM INTRODUCE.....	3
2.1 Product Introduce.....	3
The parameter of system.....	3
2.2 System Diagram.....	4
2.2.1 Multi battery string parallel connection by CAN communication between MBMS and BMS diagram (battery string qty. ≤ 6 set).....	4
2.2.2 Multi battery string parallel connection by Ethernet communication between MBMS and BMS diagram (battery string qty. ≥ 1 set).....	4
2.2.3 Diagram between BMS and battery modules:.....	4
3. INSTALLATION.....	4
3.1 Tools.....	5
3.2 Safety Gear.....	5
3.3 System Working Environments Checking.....	5
3.3.1 Cleaning.....	5
3.3.2 Temperature.....	6
3.3.3 Cooling System.....	6
3.3.4 Heating System.....	6
3.3.5 Fire-extinguisher System.....	6
3.3.6 Grounding System.....	6
3.4 Package Items.....	6
Accessories.....	6
Unpacking and check the Packing List:.....	6
3.5 Handling and placement.....	8
3.5.1 Handling and placement of the battery module.....	8
3.5.2 Handling and placement of the rack.....	9
3.5.3 The fix and installation of the rack.....	9
3.5.4 Control Module (BMS) and all Battery Modules install into the Rack.....	9
3.5.5 Install the MBMS into a 19' standard rack [If configured].....	10
3.5.6 Install the Ethernet Switch into a 19' standard rack [If configured].....	10
3.6 Cables connection.....	10
3.6.1 Pay attention terms:.....	10
3.6.2 Cables Connection.....	11
3.6.2.1 CAN Communication Mode between MBMS and BMS (battery string qty. ≤ 6 set) (battery string qty. ≤ 6 set).....	11

CAN Communication Mode between MBMS and BMS Cable Diagram :.....	12
3.6.2.2 Ethernet communication between MBMS and BMS (battery string qty. \geq 1 set).....	12
Ethernet communication between MBMS and BMS Cable Diagram:.....	13
3.6.3 ADD Switch Setting (Address Assignment).....	14
3.6.3.1 Under communication for single BMS (battery string qty. 1 set).....	14
3.6.3.2 Under CAN Communication Mode between MBMS and BMS (battery string qty. \leq 6 set).....	14
3.6.3.3 Under Ethernet communication between MBMS and BMS (battery string qty. 1~32 set).....	14
3.6.3.4 MBMS Communication Mode.....	15
3.6.4 System turns on.....	15
3.6.5 System turns off.....	17
4. SYSTEM DEBUG.....	19
5. MAINTENANCE.....	20
5.1 Trouble Shooting:.....	20
5.2 Replacement of main component.....	21
5.2.1 Replacement of Battery Module.....	22
5.2.2 Replacement of Control Module (BMS).....	22
5.2.3 Replacement of 3 rd level Control Module (MBMS).....	23
5.3 Battery Maintenance.....	24
6. STORAGE RECOMMENDATIONS.....	25
7. SHIPMENT.....	25
ANNEX 1: CABLE CONNECTION DIAGRAM (\leq6 SET).....	26
Annex 2: Ethernet communication between MBMS and BMS Cable Diagram: (>6set).....	27
ANNEX 2: INSTALLATION AND SYSTEM TURN ON PROGRESS LIST.....	28
ANNEX 3: SYSTEM TURN OFF PROGRESS LIST.....	31

1. Safety

The PowerCube-M1 is a high voltage DC system, operated by authorized person only. Read all safety instructions carefully prior to any work and observe them at all times when working on with the system.

Incorrect operation or work may cause:



- injury or death to the operator or a third party;
- damage to the system hardware and other properties belonging to the operator or a third party.

Skills of Qualified Person

Qualified personnel must have the following skills:

- training in the installation and commissioning of the electrical system, as well as the dealing with hazards;
- knowledge of the manual and other related documents;
- knowledge of the local regulations and directives.

1.1 Symbol

	Danger	<p>Lethal voltage!</p> <ul style="list-style-type: none"> ● Battery strings will produce high voltage DC power and can cause a lethal voltage and an electric shock. ● Only qualified person can perform the wiring of the battery strings.
	Warning	<p>Risk of battery system damage or personal injury</p> <ul style="list-style-type: none"> ● Do NOT pull out the connectors while the system is working! ● De-energize from all multiple power sources and verify that there is no voltage.
	Caution	<p>Risk of battery system failure or life cycle reduces.</p>



Read the product manual before operating the battery system!



Danger: Batteries deliver electric power, resulting in burns or a fire hazard when they are short circuited, or wrongly installed.

Danger: Lethal voltages are present in the battery terminals and cables. Severe injuries or death may occur if the cables and terminals are touched.



Warning: Do not open or deform the battery module;

Warning: Whenever working on the battery, wear suitable personal protective equipment (PPE) such as rubber gloves, rubber boots and goggles.

Warning: PowerCube-M1 system working temperature range: 10°C ~ 40°C; Optimum temperature: 18°C ~ 28°C. Out of the working temperature range may cause the battery reduces the cycle of life even cause the battery system over / low temperature alarm or protection. It will affect the warranty.



Caution: Improper settings or maintenance can permanently damage the battery.

Caution: Incorrect inverter parameters will lead to the premature aging of battery.

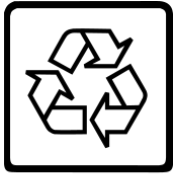

Li-ion



2. System Introduce

2.1 Product Introduce

PowerCube-M1 is a high voltage battery storage system based on lithium iron phosphate battery, is one of new energy storage products developed and produced by Pylontech, it can be used to support reliable power for various types of equipment and systems. PowerCube-M1 is especially suitable for application scene of high power, limited installation space, restricted load-bearing and long cycle life.

The parameter of system

No.		Product Type	POWERCUBE-M1 736V148AH
1	Cell Technology		Li-ion (LFP)
2	Battery System Capacity(kWh)		108.9
3	Battery System Voltage(Vdc)		736
4	Battery System Capacity(AH)		148
5	Battery Controller Name		SC1000-200
6	Battery Module Name		H32148
7	Battery Module Quantity(pcs)		23
8	Battery Module Capacity(kWh)		4.74
9	Battery Module Voltage(Vdc)		32
10	Battery Module Capacity(AH)		148
11	Battery Module Cell Series Quantity(pcs)		10
12	Battery System Charge Upper-Voltage(Vdc)		828.0
13	Battery System Charge Current(Standard)		29.6
14	Battery System Charge Current(Normal)		74
15	Battery System Charge Current(Max.)		148
16	Battery System Discharge lower-Voltage(Vdc)		621.0
17	Battery System Discharge Current(Standard)		29.6
18	Battery System Discharge Current(Normal)		74
19	Battery System Discharge Current(Max.)		148
20	Efficiency		95%
21	Depth of Discharge		90%
22	Dimension(W*D*H,mm)		815*659*2130
23	Communication		RS485\CAN
24	Protection Class		IP20
25	Weight (kg)		1250
26	Operation Life(Years)		10
28	Operation Temperature(°C)		10~40
29	Storage Temperature(°C)		-20~60
30	Humidity		5%~95%
31	Product Certificate		TUV, CE, UL
32	Transfer Certificate		UN38.3
33	Pollution Degree (PD)		II
34	Other:		330*628*150.5
	1) Battery Controller Dimensions(W*D*H)		330*628*150.5
	2) Battery Module Dimensions (W*D*H)		

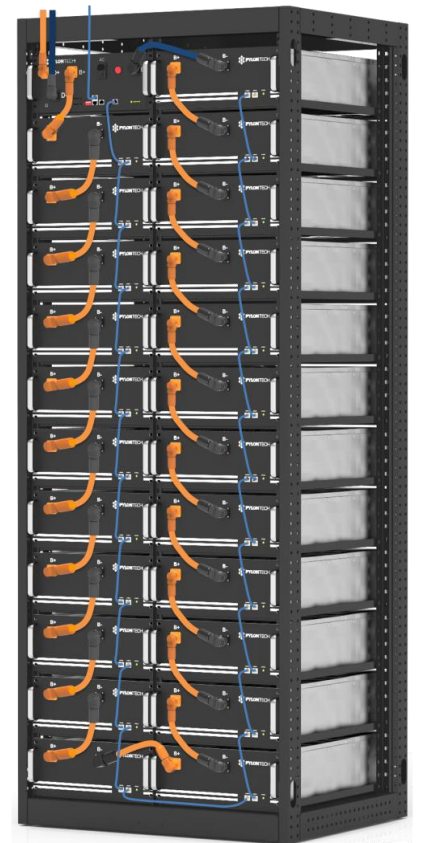

Remark: The parameter will be changed when the battery modules in different series (1~23 pcs battery modules).

2.2 System Diagram

2.2.1 Multi battery string parallel connection by CAN communication between MBMS and BMS diagram (battery string qty. ≤ 6)

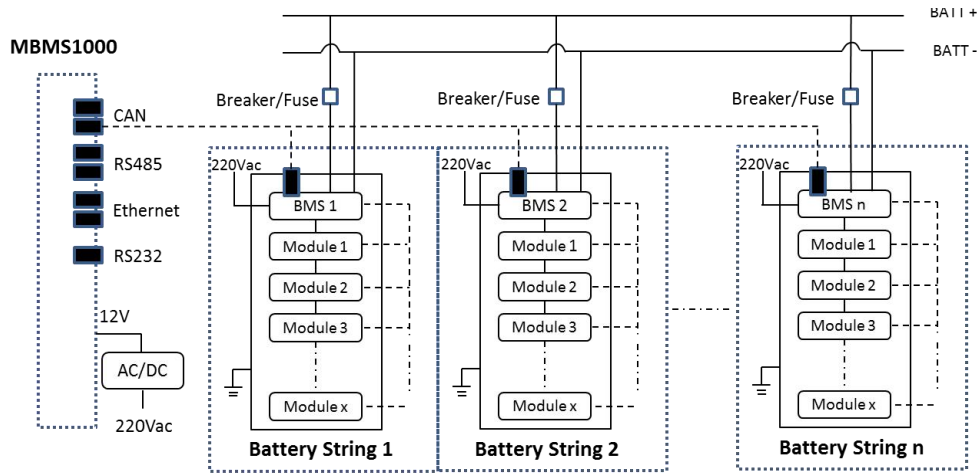

2.2.2 Multi battery string parallel connection by Ethernet communication between MBMS and BMS diagram (battery string qty. ≥ 1 set)

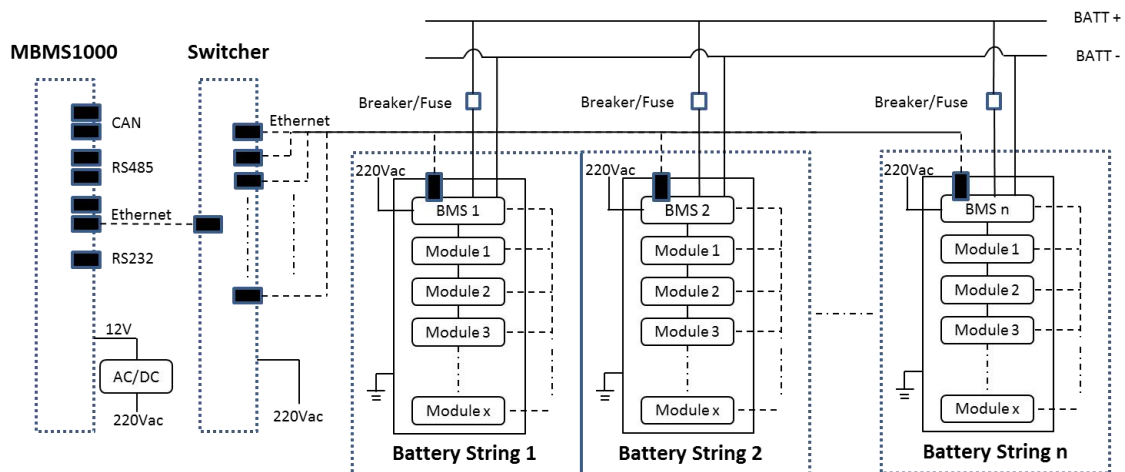

2.2.3 Diagram between BMS and battery modules:

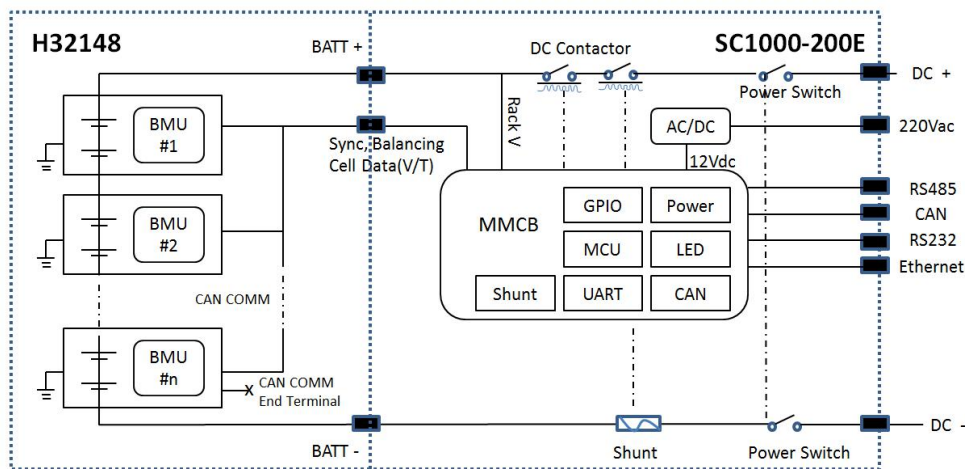

3. Installation

Please check every installation step with <Annex 2: Installation and System Turn ON Progress List> during the install.

3.1 Tools

The following tools are required to install the battery pack:

 Wire Cutter	 Crimping Modular Plier	 Cable Ties
 Screw Driver Set	 Electric Screw Driver	 1000VDC Multimeter
 Adjustable Wrench	 Sleeve Piece	

NOTE

Use properly insulated tools to prevent accidental electric shock or short circuits.

If insulated tools are not available, cover the entire exposed metal surfaces of the available tools, except their tips, with electrical tape.

3.2 Safety Gear

It is recommended to wear the following safety gear when dealing with the battery pack



Insulated gloves



Safety goggles



Safety shoes

3.3 System Working Environments Checking

3.3.1 Cleaning

The battery system has high voltage connectors. The clean condition will cause the isolation characteristic of the system.

Before installation and system working must clean the dust and iron scurf to keep the environments cleaning. And the environment must have certain anti-dust ability.



The system after long term running must check the humidity and dust cover or not. If heavy dust cover with high humidity on the system should stop the system running and make clean specially for the high voltage connectors.



Danger: the power cables and plugs still have high voltage DC power from serial connected battery modules (battery module can't be turned off), must be careful to handle the Power Plugs.

3.3.2 Temperature

PowerCube-M1 system working temperature range: 10°C ~ 40°C ; Optimum temperature: 18°C ~ 28°C.



Caution: Out of the working temperature range may cause the battery reduces the cycle of life even cause the battery system over / low temperature alarm or protection.

3.3.3 Cooling System

The room must be equipped with cooling system.



Caution: Out of the working temperature range may cause the battery reduces the cycle of life even cause the battery system over / low temperature alarm or protection.

3.3.4 Heating System

The room must be equipped with heating system. If the environment is lower than 0°C , must turn on the heating system at first.



Caution: Out of the working temperature range may cause the battery reduces the cycle of life even cause the battery system over / low temperature alarm or protection.

3.3.5 Fire-extinguisher System

The room must be equipped with fire-extinguisher system for lithium-ion battery. The fire system needs to be regularly checked to be in normal condition. Refer to the using and maintenance requirements of local fire equipment relevant.



3.3.6 Grounding System

Before the battery installation must sure the grounding point of the basement is stable and reliable. If the battery system is installed in an independent equipment cabin (e.g. container), must make sure the grounding of the cabin is stable and reliable.



The resistance of the grounding system must $\leq 100m\Omega$

3.4 Package Items

Accessories

The type and quantity of the accessories are subject to the battery packing list.

NOTE

Power cable uses water-proofed connectors. It must keep pressing this Lock Button during pulling out the power plug.

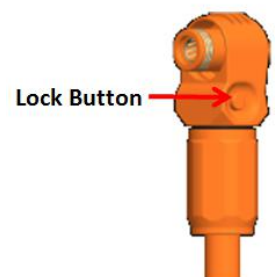

Unpacking and check the Packing List:

Power Cable + (Battery Module and Main Controller Serial Connection)	Orange/0.19m/1/0AWG/2 Orange Surlok Terminal	pcs	1
----------------------------------------------------------------------	----------------------------------------------	-----	---

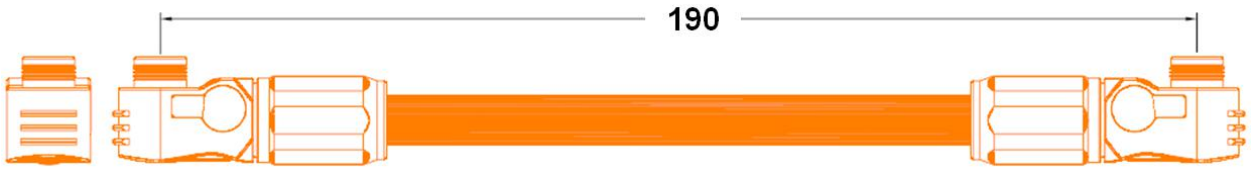

Power Cable - Battery Module and Main Controller Serial Connection)	Black/0.32m/1/0AWG/2 Black Surlok Terminal	pcs	1
---------------------------------------------------------------------	--------------------------------------------	-----	---

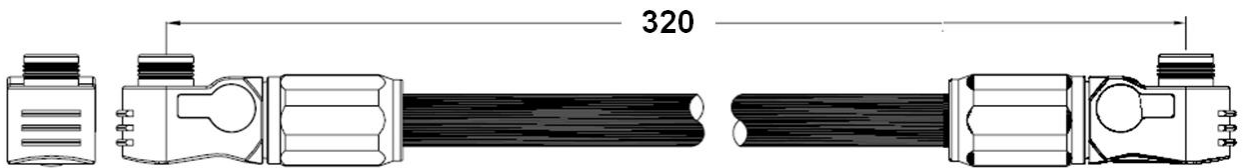

Power Cable (Battery Module Upper and Lower Serial Connection)	Orange/0.24m/1/0AWG/1 Orange & 1 Black Surlok Terminal	pcs	21
----------------------------------------------------------------	--------------------------------------------------------	-----	----

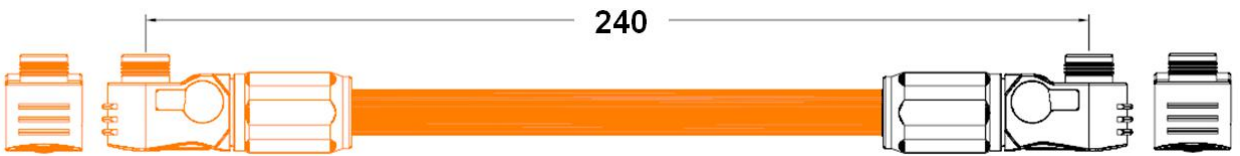

Power Cable (Battery Module Left and Right rack Serial Connection)	Orange/0.35m/1/0AWG/1 Orange & 1 Black Surlok Terminal	pcs	1
--------------------------------------------------------------------	--------------------------------------------------------	-----	---

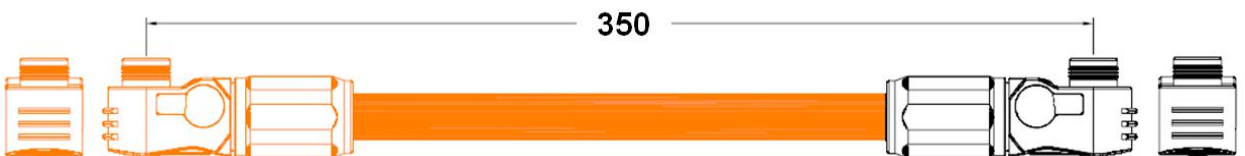

Battery Cascade Communication Cable (0.18m)	Black/0.18m/8 Core Super 5th Class Twisted-pair Wire/RJ45	pcs	22
---------------------------------------------	-----------------------------------------------------------	-----	----

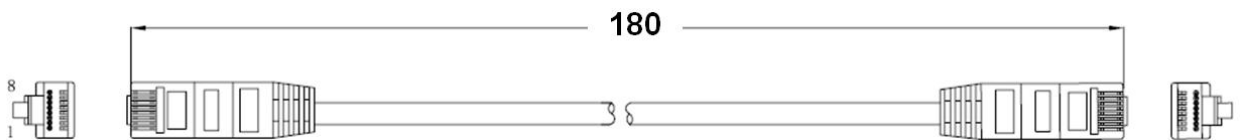

Battery Cascade Communication Cable (0.5m)	Black/0.5m/8 Core Super 5th Class Twisted-pair Wire/RJ45	pcs	1
--------------------------------------------	----------------------------------------------------------	-----	---

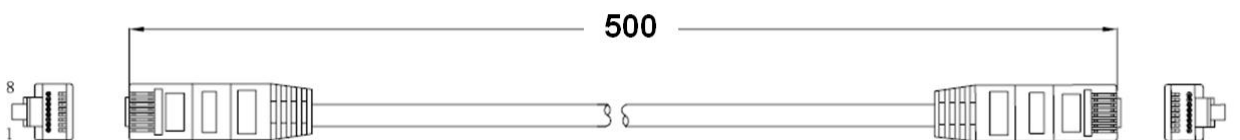

External Battery CAN Communication Cable (direct)	Black/3.5m/Super 5th Class Twisted-pair Wire/2 RJ45 terminal	pcs	1
---------------------------------------------------	--------------------------------------------------------------	-----	---

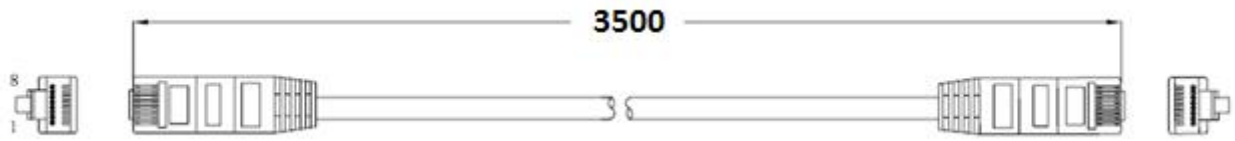

External Power Cable +	Orange/3.5m/1/0AWG/SURLOK Terminal/50-8 Terminal	pcs	1
------------------------	--------------------------------------------------	-----	---

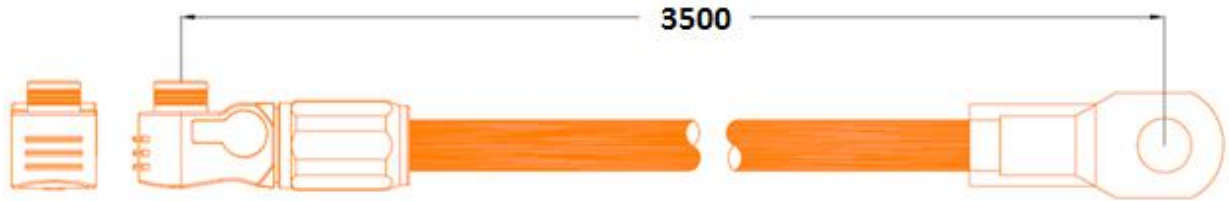

External Power Cable -	Black/3.5m/1/0AWG/SURLOK Terminal/50-8 Terminal	pcs	1
------------------------	-------------------------------------------------	-----	---



For external power supply control module there is additional AC power cable:

AC Power Cable (Australia Standard)	Black/2.5m/3*0.75mm2/Australia Standard	pcs	1
-------------------------------------	-----------------------------------------	-----	---

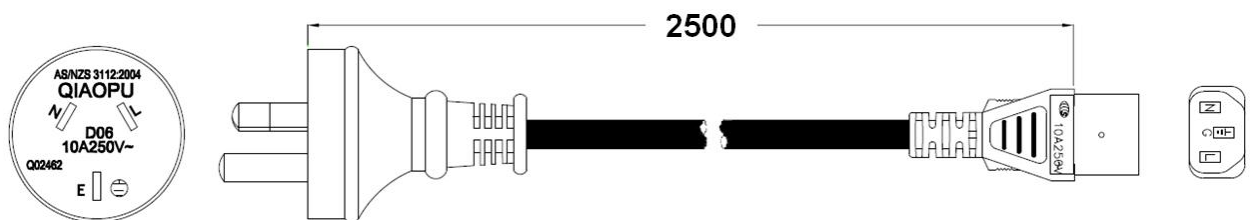

3.5 Handling and placement



Warning: The battery rack is IP00. It must be installed in a restricted access area;

Warning: The PowerCube-M1 is a high voltage DC system, operated by qualified and authorized person only.



3.5.1 Handling and placement of the battery module

Single battery module is 48kg. If without handling tools must more than 2 men to handling with it. If install in high place of the rack it must more than 3 men.

3.5.2 Handling and placement of the rack

If without handling tools must more than 4 men to handling with it.

3.5.3 The fix and installation of the rack

The rack must be fixed on the basement and carriage on the wall with M10 screws.

Battery rack basement holes bitmap (unit: mm):

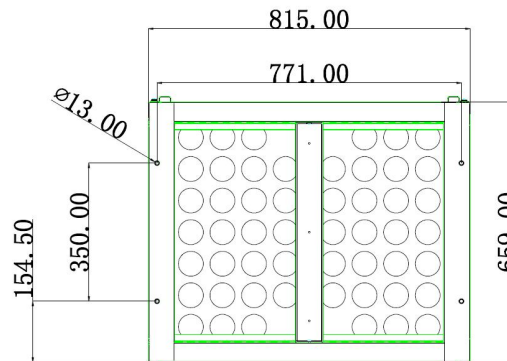

Front side

Battery rack wall fixed holes bitmap (unit: mm):

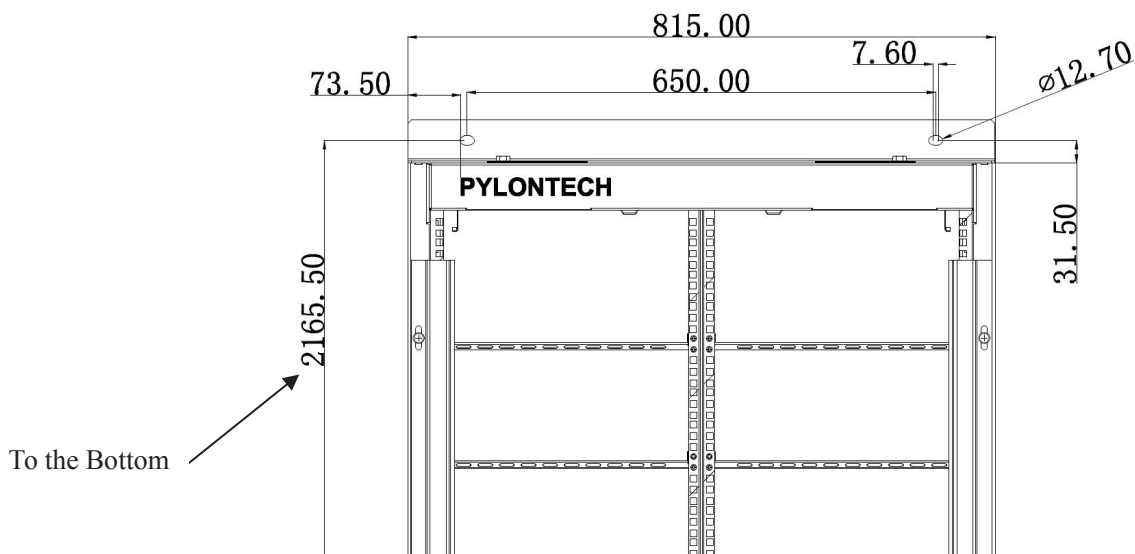

3.5.4 Control Module (BMS) and all Battery Modules install into the Rack

- Dismantle the **rack metal strip** (on the left side and right side of the rack). After installed the control module (BMS) and all battery modules need install these two stop blend back.
- Install the **buckle nuts**. The position of nuts must meet the position of the control module (BMS) and all battery modules.
- Install the control module (BMS) and all battery modules in. Each module uses 4 **screws** to fix it.

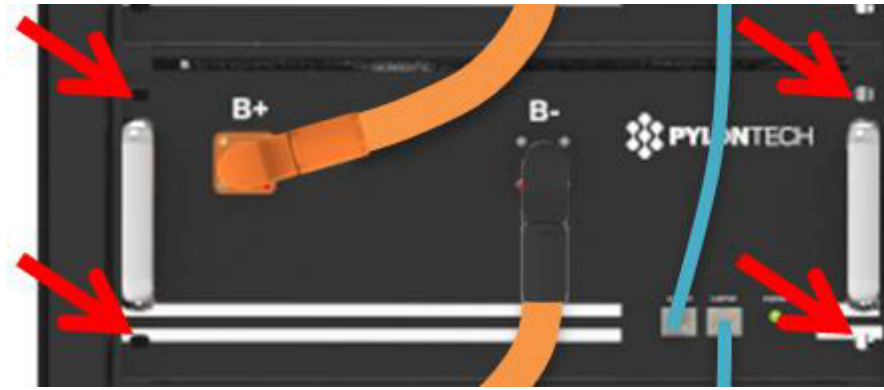

3.5.5 Install the MBMS into a 19' standard rack [If configured]

- Install the **buckle nuts**. The position of nuts must meet the position of the MBMS.
- Install the MBMS in. Uses 4 **screws** to fix it.

3.5.6 Install the Ethernet Switch into a 19' standard rack [If configured]

- Install the **buckle nuts**. The position of nuts must meet the position of the Ethernet Switch.
- Install the Ethernet Switch in. Uses 4 **screws** to fix it.

3.6 Cables connection

3.6.1 Pay attention terms:



Danger: The battery system is high voltage DC system. Must make sure the grounding of the rack is stable and reliable.

Danger: All the plugs and sockets of the power cables must be **orange to orange and black to black**. Otherwise it will cause personal injury.



Danger: No short circuit or reserved connection of the battery system's anode and cathode.

Caution: Wrong communication cables connection will cause the battery system failure.

Grounding



The PowerCube-M1 modules' grounding is based on metal directly touch between the module's surface and rack's surface. So it needn't grounding cables at all. If uses normal rack, remove the paint at the corresponding place.

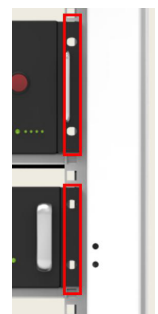

Rack Grounding:

If there is a grounding metal frame outside the rack, for example, the metal angle steel frame at the bottom of the container, the fix hole of the fix frame can be fixed directly with the metal frame of the container. Then through the grounding of the container to ensure reliable grounding.

If want to connect the ground cable, it can be connected to the M8 grounding bolt on the frame base. Grounding cable must ≥ 4 AWG.

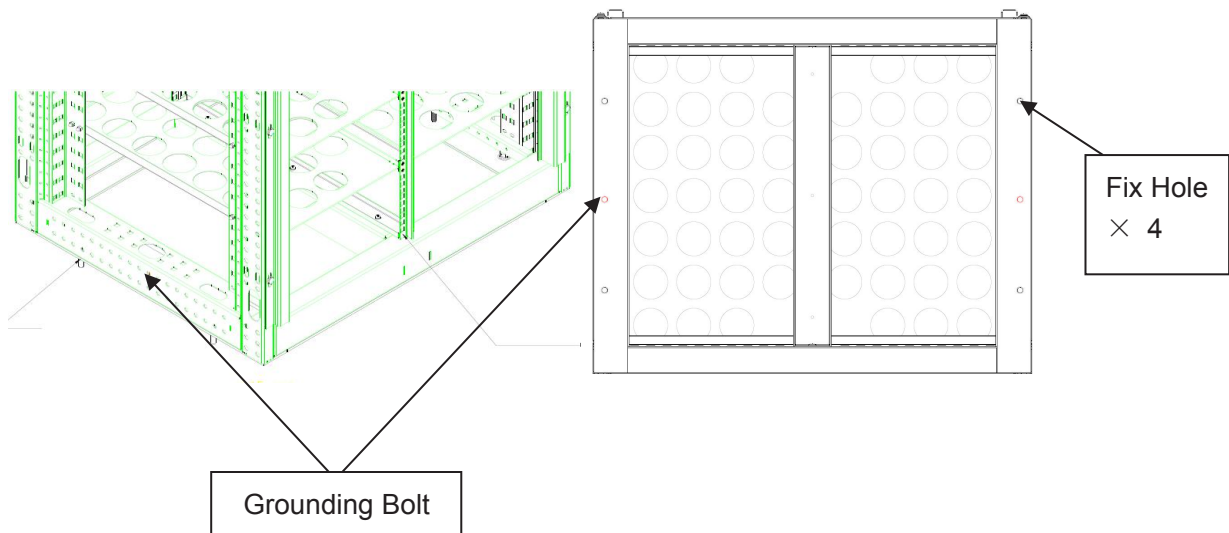

3.6.2 Cables Connection

Note: Power cable uses water-proofed connectors. It must keep pressing this Lock Button during pulling out the power plug.

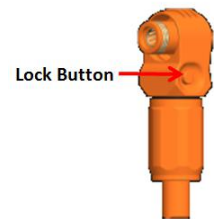

3.6.2.1 CAN Communication Mode between MBMS and BMS (battery string qty. ≤ 6 set) (battery string qty. ≤ 6 set)

When system configured PowerCube-M1 ≤ 6 set. The communication between PowerCube-M1s uses CAN cascade communication mode. The communication between the MBMS and the BMS of 1st PowerCube-M1 uses CAN communication mode.

CAN Communication Mode between MBMS and BMS Cable Diagram :

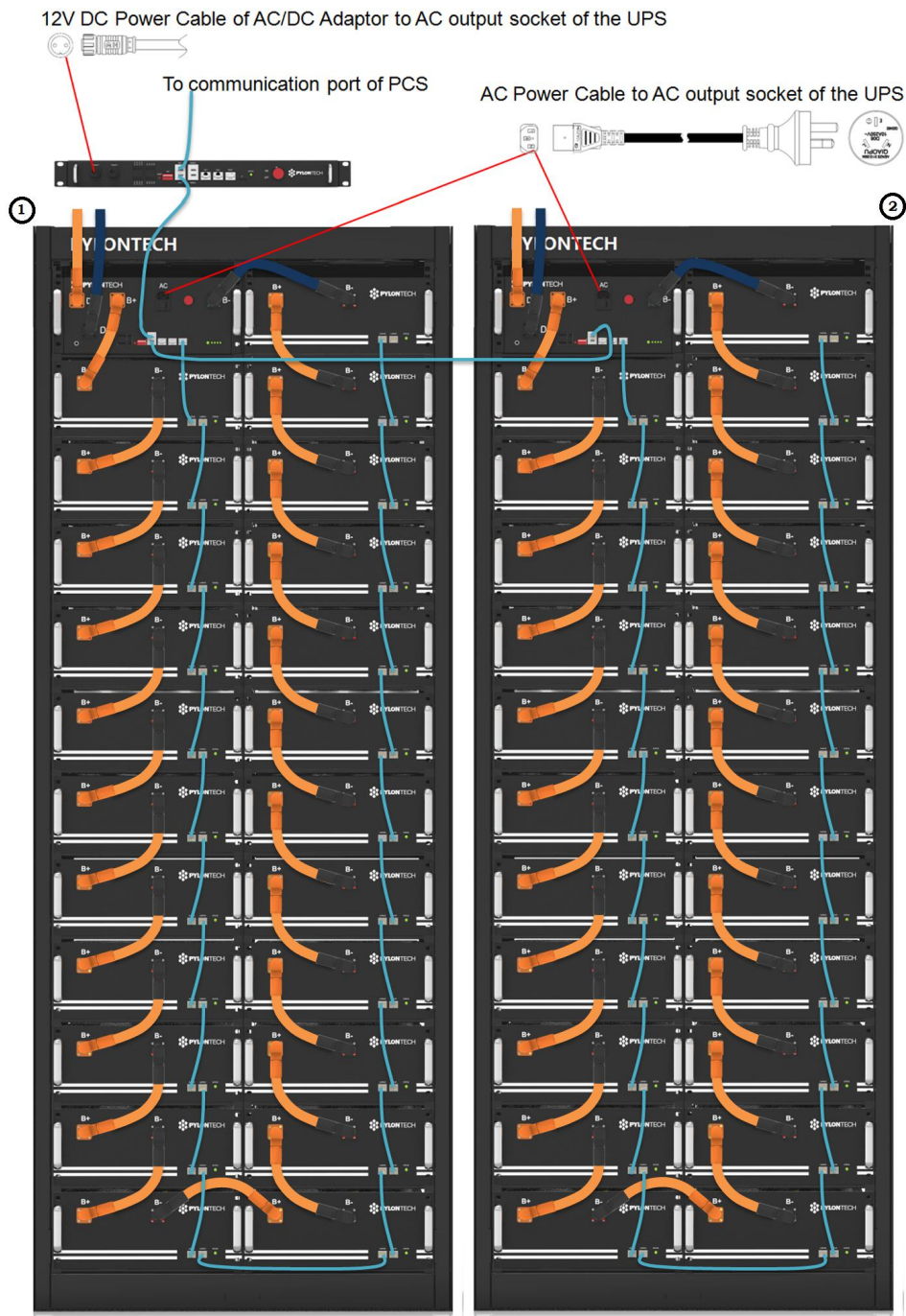

Note: The 1st PowerCube-M1 should be installed nearest by the MBMS.

3.6.2.2 Ethernet communication between MBMS and BMS (battery string qty ≥ 1 set)

A. When system configured PowerCube-M1 ≥ 1 set. The communication between PowerCube-M1s and MBMS uses Ethernet Switch by LAN communication.

Ethernet communication between MBMS and BMS Cable Diagram:

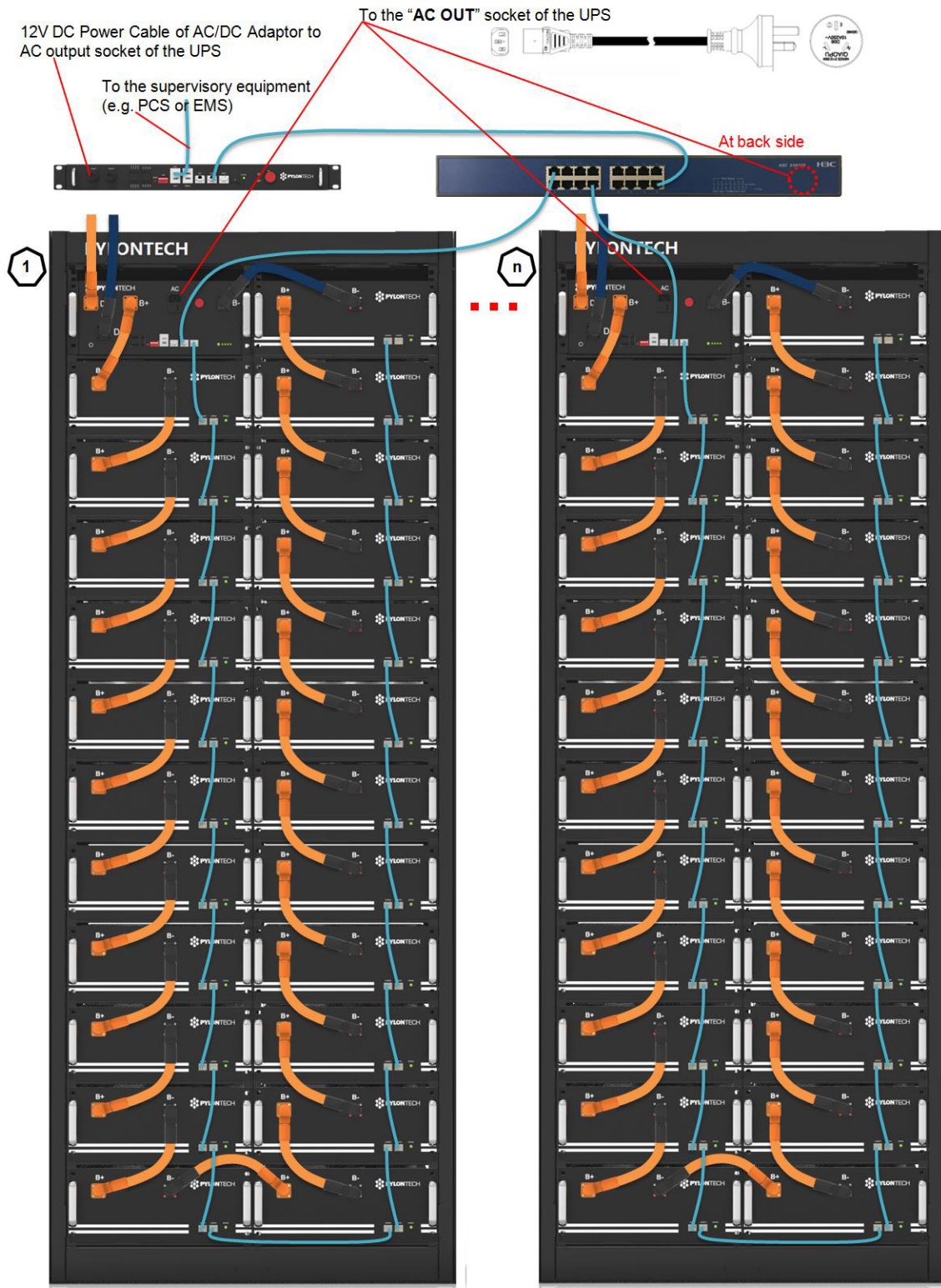

B. Relation of MBMS and battery strings (PowerCube-M1s) in the ports of Ethernet Switch

The both side of BMS to MBMS communication cable must be marked with labels.

The last port of Ethernet Switch is for the MBMS.

From the 1st port to the nth port are for the corresponding battery string (PowerCube-M1). So we can fastest find out the corresponding battery string on the Ethernet Switch.



3.6.3 ADD Switch Setting (Address Assignment)

ADD Switch is a 6 bit dial switches to manually distribute the communication address of the battery system. Nether position is OFF, means "0". Upper position is ON, means "1". 1st bit to 5th bit is for address, and the 6th bit dial switch support a 120Ω resistance (**Terminal Resistance**). ADD Switch MBMS is a 6 bit dial switches to manually distribute the communication address of the battery system. Nether position is OFF, means "0". Upper position is ON, means "1". 1st bit to 4th bit is for address, the 5th and the 6th bit dial switch support a 120Ω resistance (Terminal Resistance).

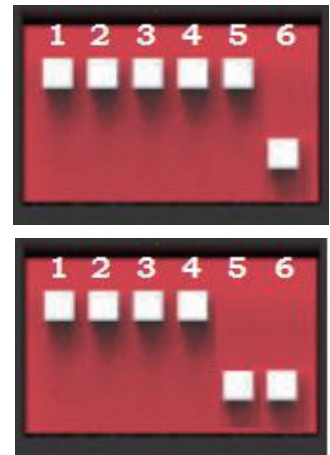

3.6.3.1 Under communication for single BMS (battery string qty. 1 set)

The BMS's first five bits must set in below <**BMS's Address Configure Table**>. The last BMS's terminal resistance must set in "1" (X=1);

The address is configured follow ASCII code: ("X" is terminal resistance).

BMS's Address Configure Table:

CAN	Modbus	Address dial bit
0	1	0000X
1	1	1000X
2	2	0100X
3	3	1100X
4	4	00100X
5	5	10100X
6	6	01100X

3.6.3.2 Under CAN Communication Mode between MBMS and BMS (battery string qty. s6 set)

The BMS's first five bits must set in below <**BMS's Address Configure Table**>. The last BMS's terminal resistance must set in "1" (X=1), and other BMS's terminal resistance must set in "0".

The address is configured follow ASCII code: ("X" is terminal resistance).

BMS's Address Configure Table:

The MBMS's ADD Switch set with "000011". The last 2 bits are terminal resistances.

Note: the 1st to 4th bit dial for MBMS refer to 3.6.3.4.

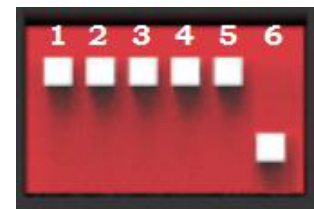

Battery String	Address Bit
1	1000X
2	0100X
3	1100X
4	00100X
5	10100X
6	01100X

3.6.3.3 Under Ethernet communication between MBMS and BMS (battery string qty. 1~32 set)

The BMS's first five bits must set in above <**BMS's Address Configure Table**>. The other BMS' terminal resistance must set in "0".

The address is configured follow ASCII code: ("X" is terminal resistance).

BMS's Address Configure Table:

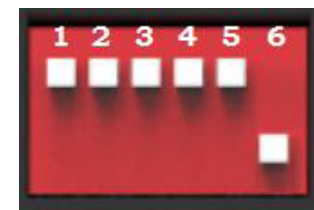

Battery String	Address Bit	Battery String	Address Bit	Battery String	Address Bit	Battery String	Address Bit
1	10000X	9	10010X	17	10001X	25	10011X
2	01000X	10	01010X	18	01001X	26	01011X
3	11000X	11	11010X	19	11001X	27	11011X
4	00100X	12	00110X	20	00101X	28	00111X
5	10100X	13	10110X	21	10101X	29	10111X
6	01100X	14	01110X	22	01101X	30	01111X
7	11100X	15	11110X	23	11101X	31	11111X
8	00010X	16	00001X	24	00011X	32	00000X

The MBMS's ADD Switch set with "000011". The last 2 bits are terminal resistances.

Note: the 1st to 4th bit dial for MBMS refer to 3.6.3.4.

3.6.3.4 MBMS Communication Mode

In some project it configures multi Energy Storage Systems. In this case will have multi MBMS. The address of MBMS must follow <MBMS's Address Configure Table>

CAN	MODBUS	address dial bit 1~4
0	1	0000
1	1	1000
2	2	0100
3	3	1100
4	4	0010
5	5	1010
6	6	0110
7	7	1110
8	8	0001
9	9	1001
10	10	0101
11	11	1101
12	12	0011
13	13	1011
14	14	0111
15	15	1111

3.6.4 System turns on



Double check all the power cables and communication cables. Make sure the voltage of the PCS is same level with the battery system. Check all the power switch of every battery system is OFF.



Warning: MBMS must be turned on after all battery strings self-check finish.

(1) Check the UPS is turned on. And the UPS is power supplying.

(2) Switch the external power or PCS on, to sure all the power equipment can work normally.

(3) Turn on the 1st BMS (Battery Control Modules) of battery string:

The second BMS must be operated after the first battery string's self-check is successful. From 1st BMS to the last BMS Then turn on the battery strings on one by one from 1st BMS to the last BMS.

- Turn on the “POWER OUTPUT SWITCH”:



- Turn on the “Power Switch”:

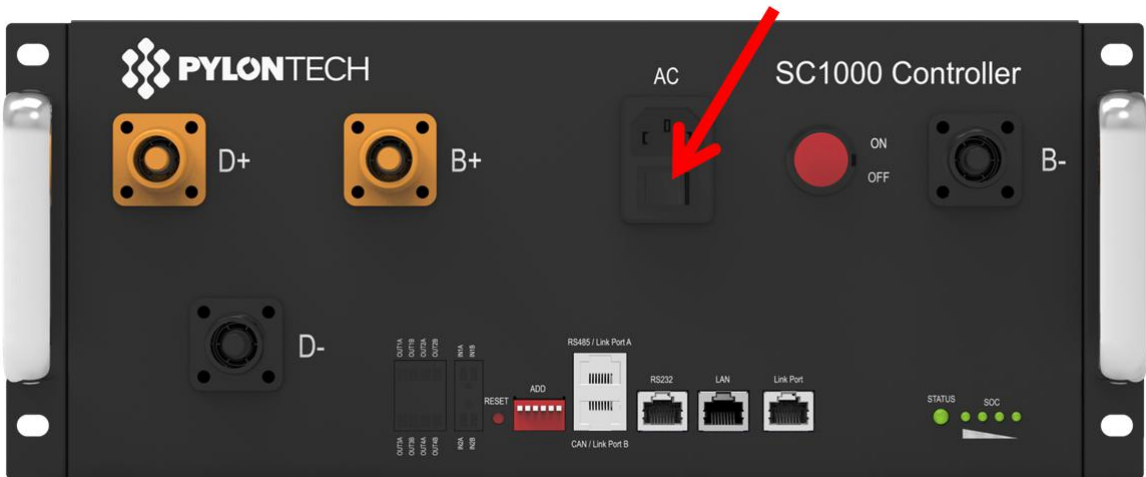

Caution: When the breaker is tripped off because the system has over current or short circuit, must after 30min to turn on it again, otherwise may cause the breaker damage.

- The battery string's system will check itself, if work normal the battery string system will go to self-check mode.
If the BMS and all battery modules are working normally, every status LED will lighting green, that's mean self-check are pass. Self-check will be finish within 5sec.
The BMS can't receive communication from upper equipment because the communication is off, the “STATUS” lamp will light red after 30sec. That doesn't means failure existing, it means this battery string is working normally.



Warning: If has failure during the self-check, must debug the failure then can start next step.

If the “STATUS” lamp shows red from beginning, it means has failure in the battery string, the Power Relays in BMS will switch ON, must debug at first.

(4) Switch the MBMS on after all the BMS turn on successful:

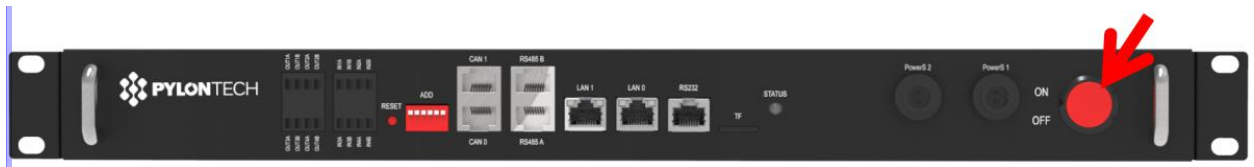

And check MBMS is working. The "STATUS" lamp will light green.

The Power Relays in BMS will switch ON after 30 seconds, when the MBMS was turned ON. The "STATUS" lamp of the BMS will light green;

When the voltage distance is smaller than the parameter, the battery string will do the parallel operation.

When the MBMS was turned ON, the "STATUS" lamp of the BMS will light red, but it is normal;

Note: If the MBMS can't build communication with other equipment, the system can't work normally. External Power should communicate with battery system through LAN, CAN or RS485. Otherwise maybe cause battery system work abnormal.



Caution: The whole Battery Energy Storage System (BESS) after installation or restart the system when long time not in using should charge it to full at first.

3.6.5 System turns off

When failure or before service, must turn the battery system off:

- (1) Turn off the switch between PCS and this battery string (PowerCube-M1), or turn off the power switch of PCS, to make sure no current through this battery string.
- (2) Turn off the "Power Output Switch" of the BMS.
- (3) Turn off the "Power Switch" of the BMS.



- (4) Turn off the "Power Switch" of the MBMS. If the ESS configures only single battery without MBMS, so needn't this operation step.



- (5) Turn off the UPS.

The UPS can turn on if have equipment must keep running can't turn off. Otherwise must turn off the UPS to save its power.



Caution: Before change the battery module for service, must charge/discharge the replaced battery same voltage to the other in system battery modules. Otherwise the system need long time to do the balance for this replaced battery module.



Warning: Do not turn off the “**Power OUTPUT Switch**” during normal running condition. Otherwise will cause this battery string current surge by another battery strings. If turned off the “Power OUTPUT Switch” in normal running condition, must first turn off the PCS.



Warning: Do not turn off the “**Power Switch**” during normal running condition. Otherwise will cause the DC relay of this Control Module adhesion. If turned off the “Power Switch” in normal running condition, must first turn off the PCS.



NOTE

After installation, do not forget to register online for full warranty:

www.pylontech.com.cn/service/support

4. System Debug

This system debug is for BESS system (Battery Energy Storage System). BESS system can't do the debug alone. It must operation with configured UPS, PCS and EMS system together.

Debug Step	Content
Prepare of debug.	Turn on the BESS system, refer to chapter 3. Before turn on the whole BESS system turn on the load is not allowed! Remark: Except the BESS, if other equipments have its own system turn on step, must follow its own system operation menu.
System function test.	Each component system debug: Power supply from the External Power Suppler (e.g. UPS) is working normally. Communication Test: Check the communication between the BESS system and communicated devices normal or not, has alarm or not. Power Conversion System Test: Before conjoint test must test the Inverter System turn on progress at first. And check the parameters meet BESS requirement or not. BESSTest: Charge/Discharge test; Test stop charging, stop discharging, current limiting functions, etc. Caution: Before turn on the BESS system must setup all the parameters of the PCS and EMS at first.
Monitor function test. (If configured.)	Check the data of the BESS system is showing on the monitor system normally.
EMS conjoint test (If configured.)	If the EMS system has running monitor requirements, checks the BESS system take action when the EMS send out the instructions.
Trial operation test.	After the system debugged, run the system a period as test (testing with low load), to test the high voltage DC system is fit for the contract.

5. Maintenance

5.1 Trouble Shooting:



Danger: The PowerCube-M1 is a high voltage DC system, operated by qualified and authorized person only.

Danger: Before check the failure, must check all the cables connection and setting of ADD Switches are right or not (refer to chapter 3), and the BESS system can turn on normally or not.

No	Problem	Possible Reason	Solution
1	Turn on the BMS. The Status LED is lighting red. But all battery modules' status LED is lighting green.	<ul style="list-style-type: none"> ● This battery string is under protection. It is possible Over Current or Failure Protection. ● Communication cables failure; ● Battery String is reversed connection. 	<ul style="list-style-type: none"> ● Through the monitor or maintenance software check the battery cell, battery module has alarm or not. ● Check the Communication Cables; ● Reversed connection is serious danger!
2	Turn on the BMS. The BMS's Status LED is lighting red and some the battery module's status LED is lighting green but some is lighting red.	This battery string is under protection. It is possible Over Current, Over Voltage, Low Voltage, Over Temperature, Low Temperature or Failure Protection.	Use the monitor or maintenance software to check the battery cell, battery module has alarm or not.
3	After turn on the BMS power Switch, the BMS still can't turn on.	<ul style="list-style-type: none"> ● External Power Supply or internal DC/DC module is abnormal; ● Power cable is broken; 	<ul style="list-style-type: none"> ● Check the external Power Supply is normal nor not. Has it enough power for the system devices because of setting of UPS. ● Check all the power cables and connections are fine or not.
4	Turn on the BMS power Switch. The Status LED shows OK. But can't output power. Turn on and turn off the "POWER OUTPUT" Switch, it has clear mechanic switching sound inside of BMS.	DC Output breaker is fault.	Check the DC output breaker is fault or not. If it is fault, change the control module (BMS module).
5	Turn on the BMS power Switch. The Status LED shows normal. But can't output power.	Electrical operation for breaker is fault.	Check the Electrical operation for breaker is fault or not. If it is fault, change the control module (BMS

	Turn on and turn off the "POWER OUTPUT" Switch, it without clear mechanic switching sound inside of BMS.		module).
6	Turn on the BMS. The Status LED is flashing red.	Self-check can't pass.	If something is wrong, please contact with seller or sells agent.
7	Turn on the BMS. The Status LED is lighting red. And the buzzer is noising.	<ul style="list-style-type: none"> ● Output relay is non-separable switching. ● The buzzer is failure; ● Output Relay Failure alarm; 	<ul style="list-style-type: none"> ● Check the output relay. If fault find out the short circuit reason. Change the relay or the control module (BMS module). ● Change the control module (BMS module).
8	Turn on the BMS. The Status LED shows normal. But the output relay can't be actuation.	The control wire of output relay is broken.	Check the wire of output relay got loose or broken? Fix it. Or change the control module (BMS module).
9	Turn on the BMS. The one and the following of the battery module's Status LED lighting red or not lighting.	<ul style="list-style-type: none"> ● This battery module has failure; ● Its communication cable failure; ● Its Address Distribution failure. 	<ul style="list-style-type: none"> ● Change this battery module; ● Check the communication cable; ● Check by professional stuff.
10	Single Cell is over voltage/ low voltage. (Check through the monitor or maintenance software.)	<ul style="list-style-type: none"> ● Cell voltage sampling failure. ● Cell failure; 	<ul style="list-style-type: none"> ● Check the wires of cell sampling module; ● Change this battery module.
11	Battery module shows the temperature is -40°C. (Check through the monitor or maintenance software.)	The wires of temperature sampling failure.	Check the wires of temperature sampling module. Or change this battery module.
12	Another failure	Cell failure or electrical board failure.	Can't find out failure point or can't check. Please contact with seller or sells agent.

5.2 Replacement of main component



Danger: The PowerCube-M1 is a high voltage DC system, operated by qualified and authorized person only.

Danger: Before replace the main component must shut off the maintenance battery string's power. Must confirm the **D+** and **D-** terminal are without power. The turn off progress refer to chapter 3.6.5.

5.2.1 Replacement of Battery Module

5.2.1.1 Use the charger to charge the new battery module charge to full (SOC 100%)

5.2.1.2 Shut off the whole battery string's power. Must confirm the **D+** and **D-** terminal are without power. The turn off progress refer to chapter 3.6.5.

5.2.1.3 Pull out the Plug of Power Cable +/- . Pull out the plug of communication cable.

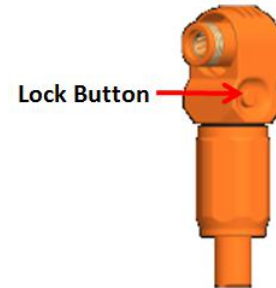
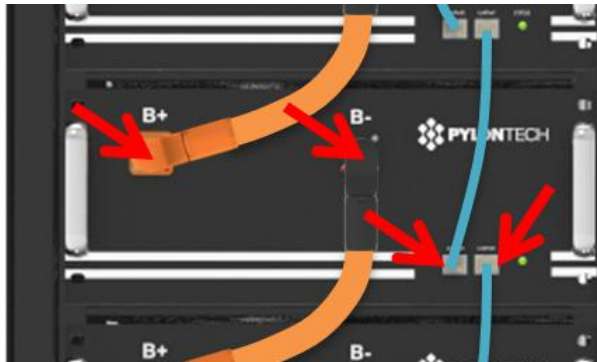

Danger: the power cables and plugs still have high voltage DC power from serial connected battery modules (battery module can't be turned off), must be careful to handle the Power plugs.

5.2.1.4 Dismantle the 4 screws of the battery module's front face.

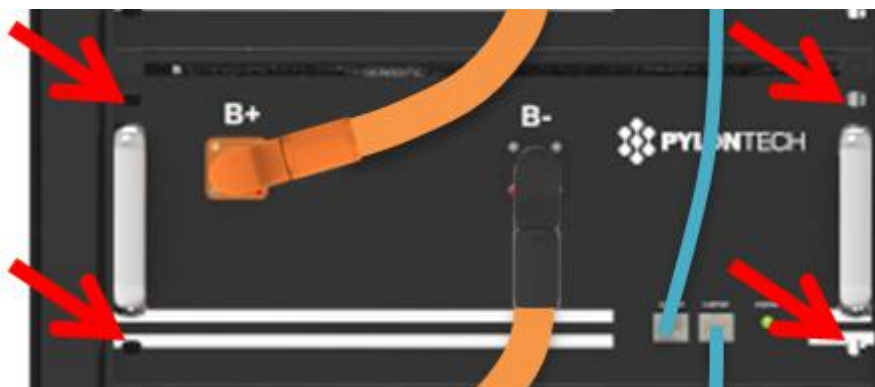

5.2.1.5 Handle the battery module out of the rack, and put it to the appoint place.

Warning: Single battery module is 48kg. If without handling tools must more than 2 men to handling with it. If install in high place of the rack it must more than 3 men.

5.2.1.6 Install the new battery module (see before 5.2.1.1). And connect the normal cables. Refer to chapter 3.5.

5.2.1.7 Turn on this battery string. Refer to chapter 3.6.

5.2.2 Replacement of Control Module (BMS)

5.2.2.1 Shut off the whole battery string's power. Must confirm the **D+** and **D-** terminal are without power. The turn off progress refer to chapter 3.6.5.

5.2.2.2 Pull out the plugs of Power Cables and the communication plugs.

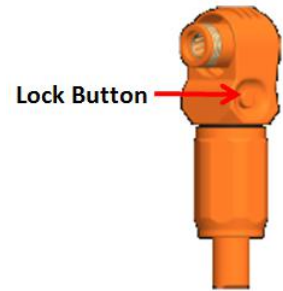

Danger: the power cables still have high voltage DC power from another battery modules, must be careful to handle the Power plugs.

5.2.2.3 Dismantle the 4 screws of the battery module's front face.



5.2.2.4 Install the new control module (BMS). And reconnect all the cables. Refer to chapter 3.5.

5.2.2.5 Turn on this battery string. Refer to chapter 3.6.



Caution: Before pull out the communication cables must mark the cable number, to avoid cable wrong sequence.

5.2.3 Replacement of 3rd level Control Module (MBMS)

5.2.3.1 Turn off the Power Switch. Refer to chapter 3.6.5.

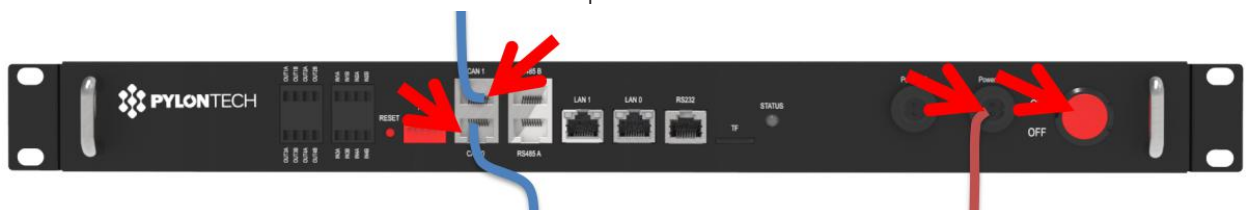

Caution: Turn off this MBMS will stop the power output of belonging whole Battery Energy Storage

System.

5.2.3.2 Dismantle the 4 screws.

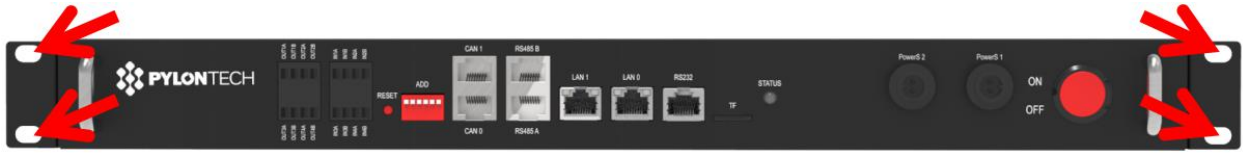

5.2.3.3 Install the new MBMS inside. And reconnect the cables. Refer to chapter 3.5.

5.2.3.4 Turn on this MBMS. Refer to chapter 3.6.



Caution: Before pull out the communication cables must mark the cable number, to avoid cable wrong sequence.



5.3 Battery Maintenance

Danger: The maintenance of battery must done by qualified and authorized person only.

Danger: Some maintenance items must shut off at first.

5.3.1 Voltage Inspection:

[Periodical Maintenance] Check the voltage of battery system through the monitor system. Check the system abnormal voltage or not. For example: Single cell's voltage is abnormal high or low.

5.3.2 SOC Inspection:

[Periodical Maintenance] Check the SOC of battery system through the monitor system. Check the battery string abnormal SOC or not.

5.3.3 Cables Inspection:

[Periodical Maintenance] Visual inspect all the cables of battery system. Check the cables has broken, aging, getting loose or not.

5.3.4 Balancing:

[Periodical Maintenance] The battery strings will become unbalance if long time not be full charged. Proposal: every 3 month should do the balancing maintenance (charge to full).

5.3.5 Output Relay Inspection:

[Periodical Maintenance] Under low load condition (low current), control the output relay OFF and ON to hear the relay has click voice, that's mean this relay can off and on normally.

5.3.6 History Inspection:

[Periodical Maintenance] Analysis the history record to check has accident (alarm and protection) or not, and analysis its reason.

5.3.7 Shutdown and Maintenance:

[Periodical Maintenance] Some battery function must be restart the ESS then can do the maintenance. So it must minimal 6 months do once.

6. Storage Recommendations

For long-term storage, if stored for a long time (more than 3 months), the battery cells should be stored in the temperature range for 5~45°C, relative humidity <65% and contains no corrosive gas environment.

The battery should shelved in 5~45°C, dry, clean and well ventilated environment. Before storage the battery should be charged to 50~55% SoC;

It is recommended to discharge and charge the battery every 3 months, and the longest discharge and charge interval shall not exceed 6 months.



Caution: If not follow the above instructions to long term store the battery, will reduce the life cycle of the battery.

7. Shipment

For single battery cell will as 50%SOC or according to customer requirement before shipment. The remaining capacity of battery cell, after shipment and before charge, is determined by the storage time and condition.

1. The battery modules meet the UN38.3 certificate standard.
2. In particular, special rules for the carriage of goods on the road and the current dangerous goods law, specifically ADR (European Convention on the International Carriage of Dangerous Goods by Road), as amended, must be observed.

Annex 1: Cable connection diagram (≤6 set)



Annex 2: Ethernet communication between MBMS and BMS Cable Diagram: (>6set)

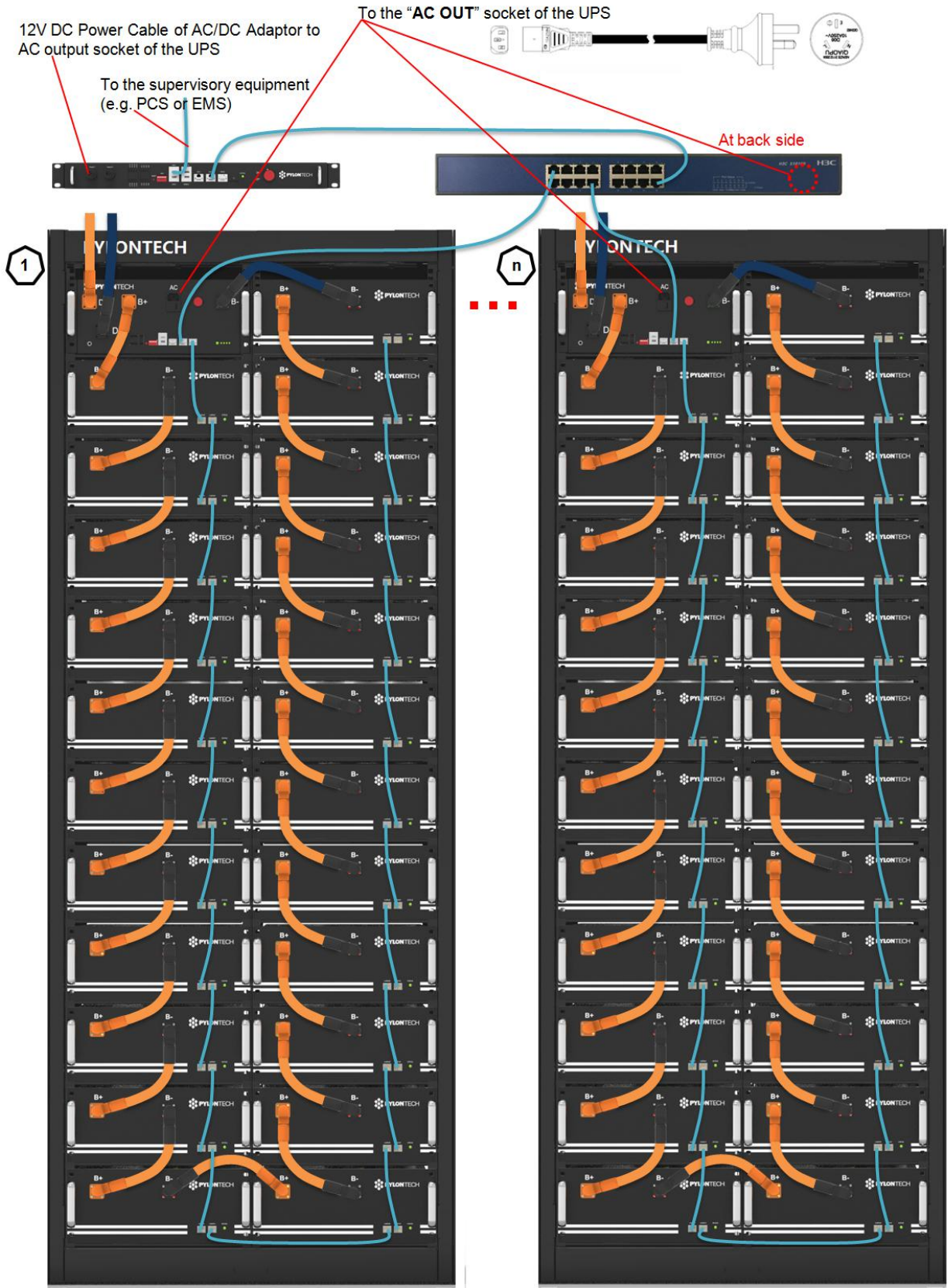

Annex 2: Installation and System Turn ON Progress List

Tick after completion	No.	Item	Remark
<input type="checkbox"/>	1	The environment is meeting all technical requirements. 3.3.1 Cleaning 3.3.2 Temperature 3.3.3 Radiating System 3.3.4 Heating System 3.3.5 Fire-extinguisher System 3.3.6 Grounding System	Refer to chapter 3.3
<input type="checkbox"/>	2	Battery rack is installed follow the technical requirements.	Refer to chapter 3.5.3.
<input type="checkbox"/>	3	Control Module (BMS) and Battery Module are installed well. And install the rack metal strip.	Refer to chapter 3.5.4.
<input type="checkbox"/>	4	The MBMS are installed well. (If configured.)	Refer to chapter 3.5.5.
<input type="checkbox"/>	5	The Ethernet Switch is installed well. (If configured.)	Refer to chapter 3.5.6.
<input type="checkbox"/>	6	Connect the AC power cables from BMS, MBMS and Ethernet Switch to the AC "OUT PUT" socket of the UPS. (If configured.)	Refer to chapter 3.6.2.1 or 3.6.2.2.
<input type="checkbox"/>	7	Connect External Power Cable +/- between each BMS to the PCS or confluence cabinet.	Refer to chapter 3.6.2.1 or 3.6.2.2.
<input type="checkbox"/>	8	Connect power cables of each battery string.	Refer to chapter 3.6.2.1 or 3.6.2.2.
<input type="checkbox"/>	9	Connect communication cables of each battery string.	Refer to chapter 3.6.2.1 or 3.6.2.2.
<input type="checkbox"/>	10	Set up ADD switch of every BMS and the MBMS (Address Assignment).	Refer to chapter 3.6.3.
<input type="checkbox"/>	11	Connect external communication cables from BMS to Ethernet Switch, MBMS or another	Refer to chapter 3.6.2.1 or 3.6.2.2.
<input type="checkbox"/>	13	Connect the communication cable from MBMS to the PCS.	Refer to chapter 3.6.2.1 or 3.6.2.2.
<input type="checkbox"/>	14	Double check every power cables, communication cables installed well. And ADD Switches are setting right.	Refer to chapter 3.6.2.1 or 3.6.2.2 and 3.6.3.
<input type="checkbox"/>	15	Check the UPS is turned on. And the UPS is power supplying.	Refer to chapter 3.6.4.
<input type="checkbox"/>	16	Switch the external power or PCS on, to sure all the power equipments can work normally.	Refer to chapter 3.6.4.
<input type="checkbox"/>	17	Turn the BMS (Battery Control Modules) of each battery string on (from 1 st BMS to the last, one by one) <ul style="list-style-type: none"> ● Turn on the "POWER OUTPUT SWITCH": ● Turn on the "Power Switch": ● The battery string's system will check itself, if 	Refer to chapter 3.6.4.

		<p>work normal the battery string system will go into self-check mode.</p> <p>If it has a failure during the self-check, it must debug the failure then can start next step.</p>	
<input type="checkbox"/>	18	<p>If every battery string are working normally.</p> <p>Then switch the MBMS on. The MBMS will self-check and check each battery string one by one.</p>	Refer to chapter 3.6.4.
<input type="checkbox"/>	19	<p>The first installation should do full charging progress.</p> <p>After MBMS has communicated with each BMS, it will run parallel operation. It will begin from lowest voltage battery string to do the parallel operation during the charging.</p> <p>If the status LED of BMS turns to green, it means this battery string is in parallel operation.</p>	The first installation should do full charging progress.

Annex 3: System Turn OFF Progress List

Tick after completion	No.	Item	Remark
<input type="checkbox"/>	1	Turn off the switch between PCS and this battery string (PowerCube-M1), or turn off the power switch of PCS, to make sure no current through this battery string.	Refer to chapter 3.6.5.
<input type="checkbox"/>	2	Turn off the "Power Output Switch" of the BMS.	Refer to chapter 3.6.5.
<input type="checkbox"/>	3	Turn off the "Power Switch" of the BMS.	Refer to chapter 3.6.5.
<input type="checkbox"/>	4	Turn off the "Power Switch" of the MBMS.	Refer to chapter 3.6.5.
<input type="checkbox"/>	5	Turn off the UPS. <ul style="list-style-type: none">• The UPS can turn on to check the equipment (PCS or battery system etc.). Otherwise must turn off the UPS to save its power.	Refer to chapter 3.6.5.



PYLONTECH

Pylon Technologies Co., Ltd.

No. 73, Lane 887, ZuChongzhi Road, Zhangjiang Hi-Tech Park
Pudong, Shanghai 201203, China

T+86-21-51317697 | **F** +86-21-51317698

E service@pylontech.com.cn

W www.pylontech.com.cn